

**THE DESIGN, CONSTRUCTION, OPERATION AND  
MAINTENANCE OF PUBLIC SWIMMING POOLS**

Excerpts from The California Health and Safety Code  
The California Code of Regulations  
California Building Code  
California Electrical Code

Reprinted with Amendments  
Through September 1, 2012

2012

Solano County  
Resource Management  
Environmental Health Division  
675 Texas Street  
Fairfield, CA 94533-6341

---

(This booklet is for informational purposes only. Should the reader want assurance that the referenced material is current the codes should be referred to directly.)

cardiopulmonary resuscitation (CPR). All these persons shall meet these qualifications by January 1, 1991. Persons who only disseminate written materials relating to water safety are not persons providing aquatic instruction within the meaning of this section. The requirements of this section shall be waived under either of the following circumstances: (a) when one or more aquatic instructors possessing the current certificates from an American Red Cross or YMCA of the U.S.A. lifeguard training program, or the equivalent, are in attendance continuously during periods of aquatic instruction, or (b) when one or more lifeguards meeting the requirements of Section 116028 are in attendance continuously during periods of aquatic instruction.

**116035. Supervising agency**

The department has supervision of sanitation, healthfulness, and safety of public swimming pools.

**116038. Filing copy of plans prior to construction of public swimming pool.**

Every person proposing to construct a public swimming pool shall file a copy of the plans therefor, prior to construction, with the local health officer having jurisdiction for approval.

**116040. Operation and maintenance in sanitary, healthful and safe manner.**

Every person operating or maintaining a public swimming pool must do so in a sanitary, healthful and safe manner.

**116043. Sanitary, healthful and safe condition of pool, appurtenances, etc.**

Every public swimming pool, including swimming pool structure, appurtenances, operation, source of water supply, amount and quality of water recirculated and in the pool, method of water purification, lifesaving apparatus, measures to insure safety of bathers, and measures to insure personal cleanliness of bathers shall be such that the public swimming pool is at all times sanitary, healthful and safe.

**116045. Necessity of lifeguard service.**

(a) Lifeguard service shall be provided for any public swimming pool that is of wholly artificial construction and for the use of which a direct fee is charged. For all other public swimming pools, lifeguard service shall be provided or signs shall be erected clearly indicating that the service is not provided.

(b) "Direct fee," as used in this section, means a separately stated fee or charge for the use of a public swimming pool to the exclusion of any other service, facility, or amenity.

**116048. Record keeping for common interest development of less than 25 units.**

(a) On or after January 1, 1987, for public swimming pools in any common interest development, as defined in Section 1351 of the Civil Code, that consists of fewer than 25 separate interests, as defined in subdivision (1) of Section 1351 of the Civil Code, the person operating each such pool open for use shall be required to keep a record of the information required by subdivision (a) of Section 65523 of Title 22 of the California Administrative Code, except that the information shall be recorded at least two times per week and at intervals no greater than four days apart.

(b) On or after January 1, 1987, any rule or regulation of the department that is in conflict with subdivision (a) is invalid.

**116049. Ground-fault interrupter**

(a) "Public swimming pool," as used in this section, means any public swimming pool defined in Section 116025 that is owned or operated by the state or any local governmental entity, including, but not limited to, any city, county, city and county, charter city, charter county, or charter city and county.

(b) All dry-niche light fixtures, and all underwater wet-niche light fixtures operating at more than 15 volts in public swimming pools shall be protected by a ground-fault circuit interrupter in the branch circuit, and all light fixtures in public swimming pools shall have encapsulated terminals. This subdivision is declaratory of existing law.

(c) Any public swimming pools that do not meet the requirements specified in subdivision (b) by January 1, 1995, shall be retrofitted to comply with these requirements by January 1, 1996.

(d) The ground-fault circuit interrupter required pursuant to this section shall comply with Underwriter's Laboratory standards.

(e) Any state or local governmental entity that owns or operates a public swimming pool shall have its public swimming pool inspected by a qualified inspector prior to July 1, 1996, to determine compliance with this section.

examination and investigation to determine the sanitary condition and whether this article, building standards published in the State Building Standards Code relating to swimming pools, or the other regulations adopted by the department pursuant to this article are being violated.

116058. Publication of inspection reports.

The department may publish the reports of inspections.

116060. Public nuisance.

Any public swimming pool constructed, operated, or maintained contrary to the provisions of this article is a public nuisance, dangerous to health.

116063. Abatement of nuisance.

Any nuisance maintained in violation of this article may be abated or enjoined in an action brought by a local health officer, or the department, or it may be summarily abated in the manner provided by law for the summary abatement of other public nuisances dangerous to health.

116064. Suction hazards at Wading Pools

(a) As used in this section the following words have the following meanings:

(1) (A) "Public wading pool" means a pool that meets all of the following criteria:

(i) It has a maximum water depth not exceeding 18 inches.

(ii) It is a pool other than a pool that is located on the premises of a one-unit or two-unit residence, intended solely for the use of the residents or guests.

(B) "Public wading pool" includes, but is not limited to, a pool owned or operated by private persons or agencies, or by state or local governmental agencies.

(C) "Public wading pool" includes, but is not limited to, a pool located in an apartment house, hotel, or similar setting, that is intended for the use of residents or guests.

(2) "Alteration" means any of the following:

(A) To change, modify, or rearrange the structural parts or the design.

(B) To enlarge.

(C) To move the location of.

(D) To install a new water circulation system.

(E) To make any repairs costing fifty dollars (\$50) or more to an existing circulation system.

(b) A public wading pool shall have at least two circulation drains per pump that are hydraulically balanced and symmetrically plumbed through one or more "T" fittings, and are separated by a distance of at least three feet in any dimension between the drains.

(c) All public wading pool main drain suction outlets that are under 12 inches across shall be covered with antivortex grates or similar protective devices. All main drain suction outlets shall be covered with grates or antivortex plates that cannot be removed except with the use of tools. Slots or openings in the grates or similar protective devices shall be of a shape, area, and arrangement that would prevent physical entrapment and would not pose any suction hazard to bathers.

(d) (1) The State Department of Health Services may adopt regulations pursuant to this section.

(2) The regulations may include, but not be limited to, standards permitting the use of alternative devices or safeguards, or incorporating new technologies, that produce, at a minimum, equivalent protection against entrapment and suction hazard, whenever these devices, safeguards, or technologies become available to the public.

(3) Regulations adopted pursuant to this section constitute building standards and shall be forwarded pursuant to subdivision (e) of Section 11343 of the Government Code to the California Building Standards Commission for approval as set forth in Section 18907 of the Health and Safety Code.

(e) The California Building Standards Commission shall approve the building standards as set forth in this section and publish them in the California Building Standards Code by November 1, 1999. The commission shall publish the text of this section in Title 24 of the California Code of Regulations, Part 2, Chapter 31B, requirements for public swimming pools, with the following note: "NOTE: These building standards are in statute but have not been adopted through the regulatory process." Enforcement of the standards set forth in this section does not depend upon adoption of regulations, therefore, enforcement agencies shall enforce the standards pursuant to the timeline set forth in this section prior to adoption of related regulations.

(f) The maximum velocity in the pump suction hydraulic system shall not exceed six feet per second when 100 percent of the pump's flow comes from the main drain system and any main drain suction fitting in the system is completely blocked.

(d) Subject to subdivisions (e) and (f), every public swimming pool with a single main drain that is not an unblockable drain shall be equipped with at least one or more of the following devices or systems that are designed to prevent physical entrapment by pool drains:

(1) A safety vacuum release system that has been tested by a department-approved independent third party and found to conform to ASME/ANSI performance standard A112.19.17, as in effect on December 31, 2009, or any applicable ASME/ANSI performance standard that has been adopted by the department pursuant to subdivision (b), or ASTM performance standard F2387, as in effect on December 31, 2009, or any applicable ASTM performance standard that has been adopted by the department pursuant to subdivision (b).

(2) A suction-limiting vent system with a tamper-resistant atmospheric opening, provided that it conforms to any applicable ASME/ANSI or ASTM performance standard that has been adopted by the department pursuant to subdivision (b).

(3) A gravity drainage system that utilizes a collector tank, provided that it conforms to any applicable ASME/ANSI or ASTM performance standard that has been adopted by the department pursuant to subdivision (b).

(4) An automatic pump shut-off system tested by a department-approved independent third party and found to conform to any applicable ASME/ANSI or ASTM performance standard that has been adopted by the department pursuant to subdivision (b).

(5) Any other system that is deemed, in accordance with federal law, to be equally effective as or more effective than, the systems described in paragraphs (1) to (4), inclusive, at preventing or eliminating the risk of injury or death associated with pool drainage systems.

(e) Every public swimming pool constructed on or after January 1, 2010, shall have at least two main drains per pump that are hydraulically balanced and symmetrically plumbed through one or more "T" fittings, and that are separated by a distance of at least three feet in any dimension between the drains. A public swimming pool constructed on or after January 1, 2010, that meets the requirements of this subdivision, shall be exempt from the requirements of subdivision (d).

(f) A public swimming pool constructed prior to January 1, 2010, shall be retrofitted to comply with subdivisions (c) and (d) by no later than July 1, 2010, except that no further retrofitting is required for a public swimming pool that completed a retrofit between December 19, 2007, and January 1, 2010, that complied with the Virginia Graeme Baker Pool and Spa Safety Act (15 U.S.C. Sec. 8001 et seq.) as in effect on the date of issue of the construction permit, or for a nonportable wading pool that completed a retrofit prior to January 1, 2010, that complied with state law on the date of issue of the construction permit. A public swimming pool owner who meets the exception described in this subdivision shall do one of the following prior to September 30, 2010:

(1) File the form issued by the department pursuant to subdivision (g), as otherwise provided in subdivision (h).

(2) (A) File a signed statement attesting that the required work has been completed.

(B) Provide a document containing the name and license number of the qualified individual who completed the required work.

(C) Provide either a copy of the final building permit, if required by the local agency, or a copy of one of the following documents if no permit was required:

(i) A document that describes the modification in a manner that provides sufficient information to document the work that was done to comply with federal law.

(ii) A copy of the final paid invoice. The amount paid for the services may be omitted or redacted from the final invoice prior to submission.

(g) Prior to March 31, 2010, the department shall issue a form for use by an owner of a public swimming pool to indicate compliance with this section. The department shall consult with county health officers and directors of departments of environmental health in developing the form and shall post the form on the department's Internet Web site. The form shall be completed by the owner of a public swimming pool prior to filing the form with the appropriate city, county, or city and county department of environmental health.

The form shall include, but not be limited to, the following information:

(1) A statement of whether the pool operates with a single or split main drain.

(2) Identification of the type of anti-entrapment devices or systems that have been installed pursuant to subdivision (c) and the date or dates of installation.

116068 Separate offense for each day.

Each day that a violation of this article continues is a separate offense.

## California Code of Regulations Title 22, Chapter 20 Public Swimming Pools

### Article 1. Definitions and Scope

#### 65501. Definitions.

(a) "Swimming Pool" or "Pool" means an artificial basin, chamber or tank used, or intended to be used, for public swimming, diving, or recreative bathing, but does not include baths where the main purpose is the cleaning of the body, nor individual therapeutic tubs.

(b) "Wading Pool" means an artificial basin, chamber or tank used, or intended to be used, for wading by small children and having a maximum depth of not to exceed 46 centimeters (18 inches) at the deepest point nor more than 30 centimeters (12 inches) at the side walls.

(c) "Special Use Pools" means pools designed and used exclusively for a single purpose such as wading, instruction, diving, competition or medical treatment where a licensed professional in the healing arts is in attendance.

(d) "Enforcing Agent" means the Health Officer or Director of Environmental Health or their designated registered sanitarian representative.

(e) "Temporary Training Pool" means an artificial basin, chamber or tank intended to be used for instruction in swimming and so constructed as to be readily disassembled for storage or for transporting to and reassembling at a different location.

(f) "Spa Pool" means a pool, not used under medical supervision, that contains water of elevated temperature, and incorporates a water jet system, an aeration system or a combination of the two systems.

(g) "Department" means the State Department of Health Services.

#### 65503. Scope.

(a) The provisions of this Chapter apply to all pools as defined in Section 65501, including but not limited to:

- (1) Commercial pools.
- (2) Real estate pools.
- (3) Community pools.
- (4) Hotel pools.
- (5) Motel pools.
- (6) Resort pools.
- (7) Auto and trailer park pools.
- (8) Auto court pools.
- (9) Apartment house pools.
- (10) Club pools.
- (11) Public or Private school pools.
- (12) Gymnasium pools.
- (13) Health establishment pools.
- (14) Townhouse pools.
- (15) Condominium pools.
- (16) Mobile home park pools.
- (17) Campground pools.
- (18) Homeowner association pools.

(b). Only private pools maintained by an individual for the use of family and friends are exempt from the provisions of this Chapter.

(c). The provisions of this Chapter shall apply to all auxiliary structures and equipment provided and maintained in connection with pools, including but not limited to:

- (1) Locker rooms.

65523. Operation Records.

(a) The operator of each pool open for use shall keep a daily record of information regarding operation, including readings of disinfectant residual, pH and maintenance procedures such as cleaning of filters and quantity of chemicals used.

(b) If cyanuric acid by itself or in a combined form with the disinfectant is added to a pool, the cyanuric acid concentration shall be measured a minimum of once per month and records shall be kept of the results of such testing.

(c) Data collected pursuant to subsections (a) and (b) shall be maintained at least one year for inspection by the enforcing agent, or shall be submitted to the enforcing agent upon his request.

65525. Recirculation and Purification System Operation.

The pumps, filters, disinfectant and chemical feeders, flow indicators, gauges and all related parts of the pool water purification system shall be kept in operation whenever the pool is available for use, and at such additional times and periods as may be necessary to maintain the water in the pool in a clear and disinfected condition. The variation in flow during a filtration cycle shall be such as to not reduce the flow below 65 percent of the rate required in Section 9032 of Title 24, California Administrative Code.

65527. Clarity of Water.

The recirculation and purification system shall be operated and maintained so as to keep the pool water clean and clear. Under no circumstances shall the pool be used if the main drain is not clearly visible from the deck. Such a pool shall be closed and shall not be reopened until the water is clean and clear, and upon specific written approval of the enforcing agent. If the pool drain is still not visible 48 hours following inspection and closure by the enforcing agent, the enforcing agent may order the pool drained as a safety precaution.

65529. Disinfection, pH Control and Cyanuric Acid.

(a) Pools, when open or in use, shall be disinfected continuously by a chemical which imparts a residual effect and shall be maintained in an alkaline condition at a pH between 7.2 and 8.0. For pools using hypochlorite or gaseous chlorine without a stabilizer, a free chlorine residual at least 1.0 ppm shall be maintained throughout the pool. If cyanuric acid or a chlorinated isocyanurate is used, a free chlorine residual of at least 1.5 ppm shall be maintained throughout the pool. The cyanuric acid concentration in any pool shall not exceed 100 ppm. Appropriate test kits for measuring the pH, concentration of the disinfectant, and, when used, concentration of cyanuric acid shall be provided at each pool. If halogens other than chlorine are used, residuals of equivalent strength shall be maintained. A test kit for measuring the concentration of the disinfectant accurate to within 0.1 ppm shall be available at each pool.

(b) When test kits for chlorine utilize comparative color standards, the standards shall be accurate to within plus or minus 0.1 ppm. There shall be at least four color standards as follows: 0.6, 1.0, 1.5 and 2.0. The test kit shall be capable of testing for free chlorine residual.

(c) The enforcing agent may accept other disinfecting materials or methods after they have been demonstrated to provide a readily measurable residual. Such materials or methods must be as effective as the required chlorine concentration and must not be dangerous to public health or create objectionable physiological effects.

65531. Bacteriological and Chemical Quality of Pool Water.

(a) Bacteriological quality of water in the pool shall be such that not more than two consecutive samples, taken when the pool is in use, shall:

(1) Contain more than 200 bacteria per millimeter, as determined by the standard (35°C) plate count; or

(2) Contain a total coliform organism MPN (most probable number) count of 2.2 or greater per 100 milliliters of sample.

(b) Chemical quality of water in the pool shall not cause irritation of eyes or skin of the bathers, or have other objectionable physiological effects on bathers.

65533. Cleanliness of Pool.

(a) Floating scum, sputum or debris shall not be allowed to accumulate in the pool. Skimmers, where provided, and water levels shall be maintained and operated to remove

(2) Pool use by the patron is approved by the enforcing agent.

65543. Wading Pool-Water Clarity.

The water of every wading pool shall be kept sufficiently clear so that the bottom of the wading pool will be visible at all times.

65545. Pool Closure.

(a) If, in the opinion of the enforcing agent, a pool is maintained or operated in a manner which creates an unhealthful, unsafe, or unsanitary condition, the pool may be closed by the enforcing agent. Such a pool shall not be reopened until correction is made, and upon, specific written approval of the enforcing agent.

(b) Unhealthful, unsafe or unsanitary conditions include, but are not limited to, the failure to meet clarity, disinfection, pH, safety or bacteriological standards.

65547. Compressed Chlorine Gas.

(a) When compressed chlorine gas is employed, the following requirements shall be met:

(1) A solution of commercial strength ammonia shall be kept available for use in testing for chlorine gas leaks.

(2) A gas mask designed for use in a chlorine atmosphere shall be provided unless a self-contained breathing apparatus meeting the requirements of paragraph (a) (3) is provided. Gas masks shall be of a type approved by the U.S. Bureau of Mines and/or the National Institute for Occupational Safety and Health. The following requirements for gas mask canisters shall be met:

(A) A replacement canister shall be provided and kept serviceable. Any canister which has been utilized during chlorine leakage shall be discarded and a replacement canister provided.

(B) The date of attaching a canister to the mask breathing tube shall be recorded on the canister. The canister shall be discarded one year from the date of attachment, or sooner if the canister is expended as shown by an indicator color change.

(C) Date stamped expired canisters shall be replaced with unexpired, unused containers.

(3) A self-contained breathing apparatus may be used in place of a gas mask only if all pool attendants and lifeguards who may be responsible for the health and safety of pool users have received formal training in the use of the equipment. Following initial formal training, responsible pool attendants and lifeguards shall receive refresher training at least once every six months if working at pools which are open year-round. For pools open on a seasonal basis, all returning responsible personnel shall receive retraining on the use of the equipment before the pool is opened for the season. The self-contained breathing apparatus provided shall comply with the provisions of Section 5144 of Title 8, California Administrative Code, and the following:

(A) Only parts approved for the specific respiratory system shall be used for replacement.

(B) The respirator equipment shall be kept at a readily accessible point outside the room in which the chlorinator is maintained.

(4) All swimming pools with gas type automatic chlorinators shall post in a conspicuous location near the entrance to the pool an emergency pool evacuation procedure.

(A) Emergency exit doors or gates shall not be locked when the pool is open for use. Keys to such doors and gates shall be readily available to pool attendants and lifeguards.

(B) Pool attendants and lifeguards shall receive training in the application of effective pool emergency procedures. Such training shall be reviewed at least once every six months for pools open year-round. For pools open on a seasonal basis, training in emergency procedures shall be conducted before the pool is opened for the season.

65549. Replacement of Equipment or Appurtenances

When fixed or installed equipment or appurtenances are changed or replaced, the change or replacement units shall meet applicable requirements of this Chapter subject to the provisions of Section 116050 of the Health and Safety Code, and shall first be cleared with the enforcing agent before substitution if not an exact duplicate of the units being changed or replaced.

## CHAPTER 31B [DPH] PUBLIC POOLS

### Division I—GENERAL

#### SECTION 3101B SCOPE

- The provisions of this chapter shall apply to the construction, installation, renovation, alteration, addition, relocation, replacement or use of any public pool and to its ancillary facilities, mechanical equipment and related piping. Public pools include those located in or designated as the following: commercial building, hotel, motel, resort, recreational vehicle or mobile home park, campground, apartment house, condominium, townhouse, homeowner association, club, community building or area, public or private school, health club or establishment, water park, swim school, medical facility, bed and breakfast, licensed day-care facility, recreation and park district, and municipal pools.

#### SECTION 3102B DEFINITIONS

- ANCILLARY FACILITY** is any area used in conjunction with or for the operation of a pool such as public dressing rooms, lockers, shower or bathroom areas, drinking fountains, equipment room, pool deck area, pool enclosure or building space that is intended to be used by pool users.
- BACKWASH** is the process of reversing the flow of water through the filter to thoroughly clean the filter media and/or elements and remove the debris from the contents of the filter vessel.
- CANTILEVERED DECKING** is the part of the deck which extends over a top edge of a pool or spa.
- CLEAN POOL WATER** is pool water that is free of dirt, oils, scum, algae, floating materials or visible organic and inorganic materials that would pollute the water.
- CLEAR POOL WATER** is pool water that is free from cloudiness and is transparent.
- COPING** is a slip-resistant cap installed on the top edge of a pool or spa.
- CORROSION RESISTANT** is capable of maintaining original surface characteristics under the prolonged influence of the use environment.
- DECK** is an area surrounding a pool which is specifically constructed or installed for use by pool users.
- DIATOMACEOUS EARTH** is a filtering media consisting of microscopic fossilized skeletons of diatoms.
- EASILY CLEANABLE** is a characteristic of a surface or material that allows removal of dirt, stains or residue by normal cleaning methods.

**EFFECTIVE PARTICLE SIZE** is the theoretical size of sieve in mm that will pass 10 percent by weight of sand.

**ENFORCING AGENT** is the health officer, director of environmental health, registered environmental health specialist or environmental health specialist trainee.

**EQUIPMENT AREA** is an area where the recirculation system and all related appurtenances are located.

**HANDHOLD** is a structure located at or above the water line around the perimeter of the pool wall that allows a pool user to hold onto the poolside for support.

**INLET** is a fitting or fixture through which recirculated water enters the pool.

**LADDER** is a series of vertically separate treads or rungs either connected by vertical rail members or independently fastened to an adjacent vertical pool wall.

**LIVING UNIT** is any building or portion thereof that contains living facilities including provisions for sleeping.

**MAIN DRAIN** is a submerged suction outlet typically located at the bottom of a pool that conducts water to a recirculating pump.

**MEDICAL POOL** is a special-purpose pool used by a State-recognized medical institution engaged in the healing arts under the direct supervision of licensed medical personnel for treatment of the infirm.

**OUTLET** is a fitting or fixture through which recirculated water is removed from the pool which may or may not be connected to the pump.

**PERFORMANCE STANDARD** is a standard that is accredited and published. Products compliant with a standard may be listed by any authorized nationally recognized testing laboratory.

**PERIMETER OVERFLOW SYSTEM** is a system which includes perimeter-type overflow gutters, surge basin or similar surface water collective system components and their interconnecting piping.

**PERMISSIBLE EXPOSURE LIMIT** is the maximum amount or concentration of a chemical that a worker may be exposed to under United States Occupational Safety and Health Administration regulations.

**POOL OR PUBLIC POOL** is an artificial basin, chamber or tank constructed or prefabricated with impermeable surfaces that is used, or intended to be used, for public swimming, diving or recreational activities but does not include individual therapeutic tubs or baths where the main purpose is the cleaning of the body. Any manmade lake or swimming lagoon with a sand beach or sand bottom is not a public pool.

**POOL OPERATOR or OPERATOR** is a person who is responsible for maintaining compliance with all requirements



## PUBLIC POOLS

relating to pool operation, maintenance and safety of pool users.

**RADIUS OF CURVATURE** is the radius arc which denotes the curved surface from the point of departure from the springline of the pool to the pool bottom.

**READILY ACCESSIBLE** is capable of being reached easily for cleaning, repair, replacement or inspection without the necessity of removing a panel, door or similar obstruction and without requiring a person to climb over or remove obstacles or to use devices such as portable ladders.

**READILY DISASSEMBLED** means capable of being taken apart by hand or by using only simple tools such as a screwdriver, pliers or open-end wrench.

**RECESSED STEPS** are a series of vertically spaced cavities in the pool wall creating riser and tread areas for pool ingress and egress.

**RECIRCULATION SYSTEM** is the system of hydraulic components designed to remove, filter, disinfect and return water to the pool.

**RIM FLOW GUTTER** is a perimeter overflow system in which the overflow rim is at the same elevation with the deck.

**SKIMMER EQUALIZER LINE** is a submerged suction outlet located below the waterline and connected to the body of a skimmer that prevents air from being drawn into the pump if the water level drops below the skimmer weir or the skimmer is blocked by debris. A skimmer equalizer line is not a main drain.

**SLIP RESISTANT** is a rough finish that is not abrasive to the bare foot.

**SPA POOL OR SPA** is a pool that incorporates a water jet system, an aeration system or a combination of the two systems used in conjunction with heated water.

**SPECIAL PURPOSE POOL** is a pool constructed exclusively for a specific purpose, such as instruction, diving, competition or medical treatment.

**SPLASH ZONE** is the maximum distance the water from a spray ground can project horizontally.

**SPRAY GROUND** is a pool with no standing water in the splash zone and consists of a surge basin with a recirculation system from which water is directed through water features for contact with pool users.

**SPRINGLINE** is the point from which the pool wall breaks from vertical and begins its arc in the radius of curvature.

**STAIRS** are a series of two or more steps.

**STEP** is a riser and tread.

**SUCTION OUTLET** is any outlet that is connected to the pump through which water is removed from the pool.

**SURGE BASIN** is a reservoir or surge trench open to the atmosphere that receives water via gravity flow from the main drain, spray ground or perimeter overflow system and from which the recirculation system operates.

**TEMPERED WATER** is water between 100°F and 110°F.

**TURNOVER TIME** is the maximum time allowed to circulate one complete volume of the pool water through the recirculation system.

**UNIFORMITY COEFFICIENT** is the ratio of the theoretical size of a sieve in mm that will pass 60 percent of the sand to the theoretical size of a sieve in mm that will pass 10 percent of the sand.

**WADING POOL** is a pool intended to be used for wading by small children and having a maximum water depth of 18 inches (457 mm) at the deepest point.

**WATER FEATURE** means an interactive device or structure through which water is directed to the pool user such as a water fountain, water spray, dancing water jet, waterfall, dumping bucket or shooting water cannon.

**WATERLINE** shall be defined in one of the following:

1. **Skimmer system.** The waterline shall be the midpoint of the operating range of the skimmers.
2. **Overflow system.** The waterline shall be the top edge of the overflow rim.

## PLAN REVIEW, PERMITS, CONSTRUCTION AND FIELD INSPECTIONS

### SECTION 3103B PLAN REVIEW

**3103B.1** A person proposing to construct, renovate or alter a pool, ancillary facilities or equipment and appurtenances shall submit plans and specifications detailing compliance with this chapter to the enforcing agent for review and written approval prior to commencing construction and shall first be cleared by the enforcing agent before substitution if not an exact duplicate of the units being changed or replaced. A local building department shall not issue a permit for a public pool or ancillary facility until the plans have been approved by the enforcing agent.

**3103B.2** Plans submitted for approval pursuant to this section shall be drawn to a scale of  $1/4$  inch (6.4 mm) equals 1 foot (305 mm), except that plans for spa pools shall be drawn to a scale of 1 inch (25 mm) equals 1 foot (305 mm), unless otherwise approved by the enforcing agent.

**3103B.3** The enforcing agent shall notify the person submitting the plans and specifications of approval or disapproval.

**3103B.4** The enforcing agent shall retain one copy of the approved plans and specifications and any subsequent changes or modifications. The approved plans shall be valid for a period of two years from the date of approval or as extended by the enforcing agent.

### SECTION 3104B CONSTRUCTION

Pools and all ancillary facilities, equipment and appurtenances shall be constructed, renovated or altered in compliance with plans approved pursuant to Section 3103B.

### SECTION 3105B PLAN COMPLIANCE INSPECTIONS

**3105B** The pool owner, operator or designated agent shall notify the enforcing agent prior to scheduling the following inspections:

1. Exposed plumbing;
2. Prior to applying pneumatically placed concrete;
3. Prior to applying the final surface to the pool shell; and
4. At the completion of construction. No pool shall be opened to the public without the written approval of the enforcing agent.

**3105B.2** The enforcing agency shall require that sufficient evidence or proof be submitted to substantiate any claims that may be made regarding its use.

**3105B.3** Whenever there is insufficient evidence of compliance with the provisions of this chapter, the enforcing agency may require tests as proof of compliance to be made at no expense to the enforcing agency. Tests shall be made in accordance with approved standards, but in the absence of such standards, the enforcing agency shall specify the test procedure.

## POOL STRUCTURE

### SECTION 3106B SPECIAL REQUIREMENTS FOR SPRAY GROUNDS

**3106B** Spray grounds. All applicable provisions of this chapter shall apply to a spray ground unless specifically addressed in this section.

**3106B.1** All parts of the spray ground shall be designed and constructed so that there are no safety hazards.

**3106B.2** Walking surface. A minimum 4-foot wide walking surface shall extend around the perimeter of the splash zone of a spray ground.

**3106B.3** The recirculation system shall be in operation at all times that the spray ground is open for use and shall have a minimum of four turnover cycles prior to opening for proper disinfection and filtration.

**3106B.4** There shall be no standing water within the splash zone.

**3106B.5** Nozzles that spray from the ground level shall be flush with the ground with openings no greater than 1/2 inch. Spray ground water features that extend above the ground must be clearly visible.

**3106B.6** The splash zone shall be sloped so that only water from the spray ground water feature flows back to the surge basin. Areas adjacent to the splash zone shall be sloped away from the spray ground to deck drains or other surface water disposal systems.

**3106B.7** All foggers and misters that produce finely atomized mists shall be supplied directly from a potable water source and not from the surge basin.

**3106B.8** When multiple pumps are used the control systems for the spray ground water feature pump and recirculation system pump shall be electrically interconnected so that when the recirculation pump is off, the spray ground water feature pump also is off.

**3106B.9** The spray ground shall have a surge basin or treatment tank constructed of materials which are inert, corrosion resistant, nontoxic and watertight including materials such as concrete, fiberglass, high density polyethylene, stainless steel or other materials as approved by the enforcing agent which can withstand all anticipated loadings under full and empty conditions as determined by an engineer or architect as defined in this chapter.

**3106B.10** The total volume of the surge basin shall be at least 4,000 gallons or a minimum of three times the gpm flow rate of all the spray ground pumps and the recirculation pump combined, whichever is higher.

**3106B.11** The turnover time shall be one-half hour or less.

**3106B.12** The suction intake for the spray ground or water feature pump in the surge basin shall be located adjacent to the recirculation return line.

**3106B.13** When separate pumps are used, the suction intake for the recirculation pump shall be located in the lowest portion of the surge basin and on the opposite side from the suction intake for the spray ground pump.

**3106B.14** The surge basin shall be designed to have easy access for cleaning and inspection. The basin shall have at least one ladder access and shall have at least one 3-foot by 3-foot access opening. Lids shall be locked or require a tool to open.

**3106B.15** The surge basin shall be equipped with an automatic make up water fill device through an air gap or be protected by an approved backflow prevention device in accordance with Chapter 6 of the California Plumbing Code.

**3106B.16** Ultraviolet light disinfection shall be used to supplement disinfection methods required in this chapter unless another treatment process is provided that has been determined by a nationally recognized testing laboratory to be capable of providing at least the equivalent level of reduction of cryptosporidium as the ultraviolet light disinfection system specified in this section. The ultraviolet light disinfection unit shall comply with the applicable requirements established by the NSF/ANSI 50-2010 performance standard effective August 2010.

**3106B.17** An accurately calibrated ultraviolet light intensity meter that has been properly filtered to restrict its sensitivity to the disinfection spectrum shall be installed in the wall of the disinfection chamber at the point of greatest water depth from the light source.

**3106B.18** The ultraviolet light unit shall be installed to provide treated water directly to the spray features.

**3106B.19** The ultraviolet light disinfection system must be equipped with an automatic shutdown system that inactivates the water feature pump if the ultraviolet dosage rate drops below 40 mJ/cm<sup>2</sup>.

**3106B.20** Artificial lighting shall be provided at all spray ground pads which are used at night or which do not have adequate natural lighting so that all portions of the spray pad and deck may be seen easily. Lighting that may be exposed to the feature pool water shall be installed in accordance with the manufacturer's specifications and the California Electrical Code.

**3106B.21** A diverter valve shall be installed on the spray ground drainage piping before the surge basin to divert water to the storm drainage system when the splash ground is not in operation.

**3106B.22** A removable and cleanable catch screen or basket shall be installed on the spray ground drainage system before it enters the reservoir to prevent larger debris from collecting in the surge basin.

**SECTION 3107B  
ALTERNATIVE EQUIPMENT, MATERIALS AND  
METHODS OF CONSTRUCTION**

**3107B.1** The enforcing agent may approve an alternative equipment, material or method of construction provided it finds that the proposed design is satisfactory and complies with the provisions of this chapter, that the equipment, material, method or work offered is, for the purpose intended, at least equivalent to that prescribed in suitability, strength, effectiveness, fire resistance, durability, safety and sanitation or that the methods of installation proposed conform to other acceptable nationally recognized standards.

**3107B.2** The enforcing agent shall require that sufficient evidence or proof be submitted to substantiate claims that may be made regarding the use of alternative equipment, material or method of construction.

**3107B.3** Whenever there is insufficient evidence of compliance with the provisions of this chapter, the enforcing agent may require tests as proof of compliance to be made at no expense to the enforcing agent. Tests shall be made in accordance with approved standards, but in the absence of such standards the enforcing agent may specify the test procedure.

**SECTION 3108B  
POOL CONSTRUCTION**

**3108B.1 Pool shell.** The pool shall be built of reinforced concrete or material equivalent in strength, watertight and able to withstand anticipated stresses under both full and empty condi-

tions taking into consideration factors such as climatic effects, geological conditions and integration of the pool with other structures.

**3108B.2 Finish.** The finished pool shell shall be lined with a smooth waterproof interior finish that will withstand repeated brushing, scrubbing, and cleaning procedures. The interior pool finish shall completely line the pool to the tile lines, coping, or cantilevered deck.

**3108B.3 Finish color.** The finish color shall be white except for the following which shall be of contrasting color:

1. Lane and other required pool markings described in Section 3110B;
2. The top surface edges of benches in spa pools;
3. The edge of pool steps;
4. Tiles installed at the waterline; and
5. Tiles installed at the 4<sup>1</sup>/<sub>2</sub>-foot (1372 mm) depth line.

**Exception:** A spa pool may be finished in a light color other than white when approved by the enforcing agent.

**3108B.4 Projections and recessed areas.** The pool shell shall not have projections or recessed areas except for pool inlets and outlets as specified in Section 3137B.

**Exception:** This section shall not apply to handholds, recessed steps, ladders, stairs, handrails, skimmers or perimeter overflow systems.

**SECTION 3109B  
POOL GEOMETRY**

**3109B.1 General.** A pool shall conform to the appropriate criteria in Figures 31B-1 through 31B-7.

**Exception:** A special purpose pool may be exempted from construction standards that are not applicable to the proposed use.

**3109B.2 Dimensional tolerances.** A construction tolerance shall be permitted on all dimensions in Figures 31B-1 through 31B-3 not to exceed 2 inches (51 mm) except that the tolerance of the water level of a pool with a nonadjustable overflow system shall not exceed 1/8 inch (3.2 mm).

**3109B.3 Bottom slope break.** Any portion of a pool having a water depth of 4<sup>1</sup>/<sub>2</sub> feet (1372 mm) or less shall have a uniform slope that shall not exceed 1 foot (305 mm) of vertical in 10 feet (3050 mm) of horizontal. In pools with water depths greater than 4<sup>1</sup>/<sub>2</sub> feet (1372 mm), the slope shall meet the requirements in Figures 31B-1 through 31B-3. There shall be a uniform water depth along the entire base of the stairs.

>

<

### SECTION 3110B PERMANENT MARKINGS

**3110B.1 General.** No markings, designs or lettering shall be permitted on the pool shell except for slip resistant lane markings, depth marking lines and safety markings.

**3110B.2 Lane markings.** Slip resistant lane lines at the bottom of the pool shall not exceed 12 inches (305 mm) in width.

**3110B.3 Depth marking line.** There shall be installed a straight line of slip resistant tile a minimum of 4 inches (102 mm) and not greater than 6 inches (152 mm) wide of a color contrasting with the background of the pool shell across the bottom of the pool where the water depth is 4½ feet (1372 mm).

**Exception:** Pools having a maximum water depth of 5 feet (1524 mm) or less shall not be required to have a depth marking line.

#### > 3110B.4 Water depth markers.

**3110B.4.1 Location.** The water depth shall be clearly marked at the following locations:

1. Maximum depth;
2. Minimum depth;
3. Each end;
4. Both sides at each end;
5. At the break in the bottom slope between the shallow and deep portions of the pool (see also Section 3109B.4); and
6. Along the perimeter of the pool at distances not to exceed 25 feet (7620 mm).

**Exception:** A spa or wading pool shall have a minimum of two depth markers indicating the maximum depth.

**3110B.4.2 Position.** Where required by Section 3110B.4.1, depth markers shall be located in the following positions:

1. On the coping or on the deck the depth markers shall be placed as close as possible but no more than 3 feet (914 mm) from the pool water; and
2. For pools with skimmer systems the depth markers shall be high at the waterline which typically will result in the depth markers being submerged approximately 50 percent; or
3. For pools with perimeter overflow systems where coping cantilevers over the gutter depth markers may be positioned at the face of the cantilevered coping, the back wall above the gutter or immediately below the waterline which will result in the depth markers being completely submerged; or
4. For pools with rim flow gutters depth markers shall be positioned immediately below the waterline which will result in the depth markers being completely submerged.

**3110B.4.3 Tolerance.** Depth markers shall be positioned to indicate the water depth accurate to the nearest 6 inches (152 mm) as measured at the waterline.

**3110B.4.4 Size of markers.** Depth markers shall:

1. Have numerals a minimum of 4 inches (102 mm) in height and of a color contrasting with the background and be marked in units of feet and inches. Abbreviations of FT and IN may be used in lieu of feet and inches; and
2. Be made of a durable material that is resistant to weathering; and
3. Be slip resistant when they are located on the pool deck.

**3110B.5 No diving markers.** For pool water depths 6 feet (1830 mm) and shallower no diving markers with the universal symbol of no diving, which is a red circle with a slash through it superimposed over the image of a diver, shall be installed on the deck directly adjacent to the depth markers required by Section 3110B.4.1. No diving markers shall comply with Section 3110B.4.4(2-3).

### SECTION 3111B STEPS, RECESSED STEPS, LADDERS AND STAIRS

**3111B.1 Construction.** A means of entry and exit to and from the pool shall consist of steps, recessed steps, ladders, stairs, ramps or a combination of these. One means of entry and exit shall be provided in the shallowest portion of a pool if the vertical distance from the bottom of the pool to the deck is over 1 foot (305 mm). A second means of entry and exit shall be provided in the deep portion of a pool having a depth greater than 4½ feet (1372 mm). Where the width of the pool exceeds 30 feet (9144 mm), such means of entry and exit shall be provided at each side, not more than 100 feet (30,480 mm) apart.

**Note:** For illustrated diagrams pertaining to this section see Figures 31B-6 and 31B-7.

**3111B.2 Ladders.** Ladders shall be corrosion resistant and shall be equipped with slip resistant tread surfaces. Ladders shall be rigidly installed and shall provide a clearance of not less than 3 inches (76 mm) or more than 5 inches (127 mm) between any part of the ladder and the pool wall.

**3111B.3 Stairs.** Stairs shall be provided in the shallowest portion of a pool. In pools with more than one shallow end stairs shall be provided at each shallow end. Each step of a stair shall have a tread in accordance with Figure 31B-7. Risers shall conform to Figure 31B-7. At least one hand rail shall be provided extending from the deck to not less than a point above the top of the lowest step installed in accordance with Figure 31B-7.

**3111B.4 Recessed steps and step risers.** Ladder treads and recessed steps shall have a minimum tread of 5 inches (127 mm) and a width of 14 inches (356 mm) and shall be designed to be readily cleaned. Step risers shall be uniform and shall not exceed 12 inches (305 mm) in height. The first riser shall be measured from the deck.

**3111B.5 Hand rails.** Hand rails shall be provided at the top of both sides of each ladder and recessed steps and shall extend over the coping or edge of the deck.

**3111B.6 Stairs for a spa pool.** Each step of a spa pool stair shall have a tread dimension in accordance with Figure 31B-7. Risers shall not exceed 12 inches (305 mm) in height. Two hand rails shall be provided extending from the deck to not less than a point above the top of the lowest step in accordance with Figure 31B-7. The steps shall be located where the deck is at least 4 feet (1219 mm) wide.

### SECTION 3112B HANDHOLDS

**3112B.1 General.** Every pool shall be provided with handholds (perimeter overflow system, bull-nosed coping or cantilevered decking) around the entire perimeter installed not greater than 9 inches (229 mm) above the waterline.

**Exception:** Handholds are not required for wading pools.

**3112B.2** For special purpose pools used for instruction or competitive swimming, a handhold at water level similar to the rim of a perimeter overflow system is required.

**3112B.3** Where perimeter overflow systems are not provided, a bull-nosed coping or cantilevered decking of reinforced concrete, or material equivalent in strength and durability, with rounded slip resistant edges shall be provided. The overhang for either bull-nosed coping or cantilevered decking shall not exceed 2 inches (51 mm) or be less than 1 inch (25 mm) and shall not exceed 2½ inches (64 mm) in thickness.

**Exception:** The enforcing agent may accept other handholds for spa pools.

### SECTION 3113B DIVING BOARDS AND PLATFORMS

**3113B.1 General.** Diving boards and platforms shall be anchored to the pool deck, constructed of corrosion resistant material, designed and constructed to be easily cleanable and finished with a durable slip resistant material.

**3113B.2 Rails and steps.** Diving boards or platforms greater than 18 inches (456 mm) in height above the deck shall be provided with a ladder or stairs for access. Hand rails shall be provided at all ladders and stairs leading to diving boards or platforms more than 1 meter above the water. Diving boards and platforms that are over 1 meter above the water shall have guard rails on both sides of the diving board or platform that extend to a point on the platform directly above the water's edge. Guard rails shall be 36 inches (914 mm) above the diving board or platform.

**3113B.3 Dimensions.** Dimensions and clearances for the use of diving boards or platforms shall conform to those shown in Figures 31B-1 and 31B-2. Platforms and diving boards shall conform to the USA Diving Rules and Codes, Part 1, Subpart A and Appendix B, effective January 1, 2010.

### SECTION 3114B POOL DECKS

**3114B.1 General.** A minimum continuous and unobstructed 4-foot wide (1219 mm) slip resistant, cleanable, nonabrasive deck area of concrete or like material shall be provided flush with the top of the pool coping extending completely around the pool, and the deck area shall further extend 4 feet (1219 mm) on both sides and rear of any diving board, fixed disabled access assistance device or slide and their appurtenances. The deck width shall be measured from the poolside edge of the coping lip.

**Exception:** A deck at least 4 feet (1219 mm) in width shall extend around a continuous 50 percent or more of the perimeter of a spa pool. For spa pools that have their walls extending above the ground or floor level, the deck area requirement shall apply at the ground or floor level unless otherwise approved in writing by the enforcing agent.

**Note:** [DSA-AC] Any mechanism provided to assist persons with disabilities in gaining entry into the pool and in exiting from the pool shall comply with Chapter 11B, Section 1104B4.3, Participation Areas.

**3114B.2 Deck between pools and/or spas.** Where multiple pools and/or spas are built adjacent to each other, the deck width separating them shall be a minimum of 6 feet (1830 mm).

**3114B.3 Deck slope.** The pool's deck surface shall have a slope of no less than 1 percent (¼ inch per foot) but no more than 2 percent (½ inch per foot) away from the pool to a deck drainage system and shall be constructed and finished to prevent standing water.

**3114B.4 Deck covering.** Deck coverings or other materials that are not equivalent to concrete in strength, durability and slip resistance and are not able to withstand repeated brushing, scrubbing or cleaning procedures shall not be installed or used within 4 feet (1219 mm) of the pool.

**3114B.5 Unpaved areas.** Landscape plants, flower beds or similar unpaved areas shall not be located within 4 feet (1219 mm) of a spa pool.

### SECTION 3115B POOL LIGHTING

**3115B.1 General.** Pools shall have underwater and deck lighting such that lifeguards or other persons may observe, without interference from direct and reflected glare from the lighting sources, every part of the underwater area and pool surface, all diving boards or other pool appurtenances. If underwater or deck surface lighting is not operational, the operator of the pool shall secure the pool area and not permit any use of the pool after dark and shall post the same sign as required in Section 3120B.9.

**Note:** See Part 3, Article 3-680, Title 24, California Code of Regulations for electrical installation requirements.

**3115B.2 Nighttime use.** Pools used at night shall be equipped with underwater lighting fixtures that will provide complete illumination to all underwater areas of the pool with no blind spots. Illumination shall enable a lifeguard or other persons to determine whether:

1. A pool user is lying on the bottom of the pool; and
2. The pool water conforms to the definition of "clear pool water."

**Exception:** Pools provided with a system of overhead lighting fixtures where it can be demonstrated to the enforcing agent that the system is equivalent to the underwater lighting fixture system.

**3115B.3 Deck area lighting.** When the pool is to be used at night, pool deck areas and emergency egress areas shall be provided with lighting so that persons walking on the deck can identify hazards. Lighting fixtures shall be aimed towards the deck area and away from the pool surface insofar as practical.

## ANCILLARY FACILITIES

### SECTION 3116B BATHHOUSE, DRESSING, SHOWER AND TOILET FACILITIES

**3116B.1** Shower and dressing facilities shall be provided for users of a pool.

**Exceptions:**

1. Shower and dressing facilities may not be required when bathers have access to such facilities in adjacent living quarters.
2. Public toilet facilities may be omitted when bathers have access to toilet facilities either in living quarters located not more than 300 feet (91,440 mm) in travel distance from the pool, or in an adjacent building such as a recreational facility, clubhouse or cabana.

**3116B.2 Number of sanitary facilities.** For the purpose of this subsection, one bather shall be considered for every 15 square feet (1.39 m<sup>2</sup>) of pool water surface area.

**3116B.2.1 Showers.** One shower shall be provided for every 50 bathers.

**3116B.2.2 Toilets.** Separate toilet facilities shall be provided for each sex. One toilet shall be provided for every 60 women or less and one toilet plus one urinal for every 75 men or less.

**3116B.2.3 Lavatories.** One lavatory shall be provided for every 80 bathers.

**3116B.3 Construction.**

**3116B.3.1 Floors.** Floors shall have a hard, nonabsorbent surface, such as portland cement concrete, ceramic tile or other approved material, which extends upwards onto the wall at least 5 inches (127 mm) with a coved base. Floors which may be walked on by a wet bather shall be slip resis-

tant. Floors shall be sloped not less than 1/4 inch (6.4mm) per foot to floor drains or other approved surface water disposal areas. Carpeting and other similar artificial floor covering shall not be permitted on shower and toilet room floors.

**Note:** Rough rotary, raised rubber or wood float finish of concrete usually provides a slip-resistant finish.

**3116B.3.2 Interior surfaces.** The materials used in the walls, except for structural elements, shall be of a type which is not adversely affected by moisture.

**3116B.3.3 Privacy.** All doors and windows shall be arranged to prevent viewing of the interior from any portion of the building used by the opposite sex and from view from the outdoors. View screens shall be permitted for this purpose.

**3116B.4 Water supply.**

**3116B.4.1** Showers and lavatories shall be provided with hot and cold water faucets.

**3116B.4.2** Tempered water shall be permitted in lieu of individual hot and cold water faucets.

**3116B.4.3** A means to limit the hot water to 110°F (61°C) maximum shall be provided to prevent scalding. This temperature limit control shall not be adjustable by the bather.

### SECTION 3117B DRINKING FOUNTAINS

One guarded jet drinking fountain shall be provided for the first 250 bathers and an additional fountain shall be provided for each additional 200 bathers or fraction thereof. The number of bathers shall be determined according to Section 3116B.2.

**Exception:** Drinking fountains shall not be required when drinking water is available at adjacent living quarters, or in an adjacent building such as a bathhouse, cabana, clubhouse or recreational facility.

### SECTION 3118B HOSE BIBBS

Potable water outlets with hose attachments shall be protected by a nonremovable hose bibb backflow preventer, a nonremovable hose bibb vacuum breaker, or by an atmospheric vacuum breaker installed not less than 6 inches (152 mm) above the highest point of usage located on the discharge side of the last valve as required by the California Plumbing Code. In climates where freezing temperatures occur, a listed self-draining frost-proof hose bibb with an integral backflow preventer or vacuum breaker shall be used. Hose bibbs shall be provided so that all portions of the pool deck area may be reached with a 75 foot length of hose attached to the hose bibb. A hose bibb shall be provided in the equipment area. Hose bibbs shall be located so that they do not constitute a hazard.

### SECTION 3119B POOL ENCLOSURE

**3119B.1 Enclosure.** The pool shall be enclosed by one or a combination of the following: a fence; portion of a building; wall; or other approved durable enclosure. Doors, windows gates of living units or associated private premises shall not be permitted as part of the pool enclosure. The enclosure, doors and gates shall meet all of the following specifications:

1. The enclosure shall have a minimum effective perpendicular height of 5 feet (1524 mm) as measured from the outside as depicted in Figure 31B-4;
2. Openings, holes or gaps in the enclosure, doors and/or gates shall not allow the passage of a 4-inch (102 mm) diameter sphere. The enclosure shall be constructed over a hard and permanent material equivalent to concrete; and
3. The enclosure shall be designed and constructed so that it cannot be readily climbed by small children. Horizontal and diagonal member designs which might serve as a ladder for small children are prohibited. Horizontal members shall be spaced at least 48 inches (1219 mm) apart. No planters or other structures that can be climbed shall be permitted within 5 feet (1524 mm) of the outside of the pool enclosure or within a 5 foot (1524 mm) arc as depicted in Figure 31B-5. The area 5 feet (1524 mm) outside of the pool enclosure shall be a common area open to the public.
4. Chain link may be used, provided that the openings are not greater than 1<sup>3</sup>/<sub>4</sub> inches (44 mm) measured horizontally.

**3119B.2 Gates.** Gates and doors opening into the pool enclosure also shall meet the following specifications:

1. Gates and doors shall be equipped with self-closing and self-latching devices. The self-latching device shall keep the gate or door securely closed. Gates and doors shall open outwardly away from the pool except where otherwise prohibited by law. Hand activated door or gate opening hardware shall be located at a height no lower than 42 inches (1067 mm) but no higher than 44 inches (1179 mm) above the deck or walkway; and
2. Gates and doors shall be capable of being locked during times when the pool is closed. Exit doors which comply with Chapter 10, Title 24, California Code of Regulations shall be considered as meeting these requirements; and
3. The pool enclosure shall have at least one means of egress without a key for emergency purposes. Unless all gates or doors are so equipped, those gates and/or doors which will allow egress without a key shall have a sign in letters at least 4 inches (102 mm) high stating **EMERGENCY EXIT**; and
4. The enclosure shall be constructed so that all persons will be required to pass through common pool enclosure gates or doors in order to gain access to the pool area. All gates and doors exiting the pool area shall open into a public area or a walkway accessible by all patrons of the pool.

**3119B.3 Retroactivity.** Sections 3119B.1 and 3119B.2 shall apply only to public pool enclosures constructed on or after July 1, 1994. Notwithstanding the foregoing effective date, no fence enclosure shall be less than 4 feet (1219 mm) in height.

**3119B.4 Enclosure of pools constructed prior to July 1, 1994.**

The enforcing agent may allow the installation of an enclosure which reduces the pool deck to less than 4 feet (1219 mm) in width when the physical characteristics of a site preclude providing a 4-foot (1219 mm) wide deck around the perimeter of an existing pool.

### SECTION 3120B REQUIRED SIGNS

**3120B.1 General.** All signs shall have clearly legible letters or numbers not less than 4 inches (102 mm) high, unless otherwise required in this section, affixed to a wall, pole, gate or similar permanent structure in a location visible to all pool users.

**3120B.2 Pool user capacity sign.** A sign shall indicate the maximum number of pool users permitted for each pool.

**3120B.2.1 Spa pool.** The pool user capacity of a spa pool shall be based on one pool user for every 10 square feet (0.929 m<sup>2</sup>) of pool water surface area.

**3120B.2.2 Other pools.** The pool user capacity for all other pools shall be based on one pool user for every 20 square feet (1.858 m<sup>2</sup>) of pool water surface area.

**Exception:** Pool user capacity requirements do not apply to wading pools or spray grounds.

**3120B.3 No diving sign.** Signs shall be posted in conspicuous places and shall state, "NO DIVING" at pools with a maximum water depth of 6 feet or less.

**3120B.4 No lifeguard sign.** Where no lifeguard service is provided, a warning sign shall be posted stating, "WARNING: NO LIFEGUARD ON DUTY." The sign also shall state in letters at least 1 inch (25 mm) high, "Children under the age of 14 shall not use pool without a parent or adult guardian in attendance."

**3120B.5 Artificial respiration and CPR sign.** An illustrated diagram with text at least 1/4 inch (6 mm) high of artificial respiration and CPR procedures shall be posted.

**3120B.6 Emergency sign.** The emergency telephone number 911, the number of the nearest emergency services and the name and street address of the pool facility shall be posted.

**3120B.7 Warning sign for a spa pool.** A warning sign for spa pools shall be posted stating, "CAUTION" and shall include the following language in letters at least 1 inch (25 mm) high:

1. Elderly persons, pregnant women, infants and those with health conditions requiring medical care should consult with a physician before entering the spa.
2. Unsupervised use by children under the age of 14 is prohibited.
3. Hot water immersion while under the influence of alcohol, narcotics, drugs or medicines may lead to serious consequences and is not recommended.
4. Do not use alone.
5. Long exposure may result in hyperthermia, nausea, dizziness or fainting.

**3120B.8 Emergency shut off.** In letters at least one inch (25 mm) high a sign shall be posted at the spa emergency shut off switch stating, "EMERGENCY SHUT OFF SWITCH."

**3120B.9 No use after dark.** Where pools were constructed for which lighting was not required, a sign shall be posted at each pool entrance on the outside of the gate(s) stating, "NO USE OF POOL ALLOWED AFTER DARK."

**3120B.10 Keep closed.** A sign shall be posted on the exterior side of gates and doors leading into the pool enclosure area stating, "KEEP CLOSED."

**3120B.11 Diarrhea.** A sign in letters at least 1 inch (25 mm) high and in a language or diagram that is clearly stated shall be posted at the entrance area of a public pool which states that persons having currently active diarrhea or who have had active diarrhea within the previous 14 days shall not be allowed to enter the pool water.

**3120B.12 Wave pools.** A sign in letters at least 1 inch (25 mm) high shall be posted that describes the requirements for wave pools as described in Section 115952, Health and Safety Code.

**3120B.13 Spray ground sign.** A sign shall be posted at each spray ground and be visible from any part of the spray ground that states, "CAUTION: WATER IS RECIRCULATED. DO NOT DRINK."

**3120B.14 Exit.** Where automatic gaseous chlorine chemical feeders are used, a sign shall be posted at the pool area entrance which shows in a diagrammatic form an emergency evacuation procedure. Designated emergency exits shall be marked "EXIT."

**3120B.15 Gaseous oxidizer.** Where automatic gaseous chlorine chemical feeders are used, a warning sign with the appropriate hazard identification symbol shall be posted on the exterior side of the door entering the chemical feeder room or area. The sign shall state, "DANGER: GASEOUS OXIDIZER - (specific chemical name)," or as otherwise required by the California Fire Code.

**3120B.16 Turn on before entering.** Where automatic gaseous chemical feeders are used, a sign shall be posted at the switch to the light and ventilation system for the gaseous chemical feeder room stating, "TURN ON BEFORE ENTERING," or as otherwise required by the California Fire Code or the California Electrical Code.

**3120B.17 Direction of flow.**

**3120B.17.1.** The direction of flow for the recirculation equipment shall be labeled clearly with directional symbols such as arrows on all piping in the equipment area.

**3120B.17.2.** Where the recirculation equipment for more than one pool is located on site, the equipment shall be marked as to which pool the system serves.

**3120B.17.3.** Valves and plumbing lines shall be labeled clearly with the source or destination descriptions.

### SECTION 3121B INDOOR POOL VENTILATION

Indoor pools, dressing rooms and toilet rooms shall be ventilated according to the requirements in Chapter 4 of the California Mechanical Code.

### SECTION 3122B POOL EQUIPMENT ENCLOSURE

For pools constructed on or after January 1, 2013, pool equipment shall be enclosed as follows:

1. All equipment installed for recirculation, filtration and disinfection of pool water shall be installed so that access is limited to persons authorized by the pool owner or operator;
2. Pool equipment shall be mounted on a continuous slab of concrete or other equivalent easily cleanable and nonabsorbent material; and
3. Floors shall be sloped a minimum of  $1/4$  inch (6.4 mm) per foot to a drain.

### RECIRCULATION SYSTEM COMPONENTS

### SECTION 3123B GENERAL REQUIREMENTS

**3123B.1 System description.** Each pool shall be provided with a separate recirculation system designed for the continuous recirculation, filtration and disinfection of the pool water. The system shall consist of pumps, filters, chemical feeders, skimmers or perimeter overflow systems, valves, pipes, connections, fittings and appurtenances.

**Exception:** Pools using fresh water equivalent in flow to the requirements of Section 3124B.

**Note:** Fresh makeup pool water shall conform to the water quality standards of Section 65531, Chapter 20, Title 22, California Code of Regulations.

**3123B.2 Equipment.** All pumps, filters, chemical feeders, skimmers and supplemental equipment shall comply with the applicable requirements established by the NSF/ANSI 50-2010 performance standard effective August 2010.

**3123B.3 Installation.** All equipment related to pool operations shall be installed and maintained according to this chapter and in accordance with the equipment manufacturer's written instructions.

**3123B.4 Equipment access.** All filters, valves, pumps, strainers and equipment shall be readily accessible for repair and replacement.

### SECTION 3124B TURNOVER TIME

The recirculation system shall have the capacity to provide a complete turnover of pool water in:

1. One-half hour or less for a spa pool;
2. One-half hour or less for a spray ground;
3. One hour or less for a wading pool;
4. Two hours or less for a medical pool; and
5. Six hours or less for all other types of public pools.



### SECTION 3125B RECIRCULATION PIPING SYSTEM AND COMPONENTS

**3125B.1 Line sizes.** Pipes shall be sized so flow velocity of piping systems including all parts and fittings other than inlet devices or venturi throats shall not exceed 6 feet per second (1.829 m/s) in any suction or copper piping and 8 feet per second (2.438 m/s) in any portion of the return system.

**3125B.1.1 Materials.** All pipe, tube and fittings shall comply with the applicable standards for potable water system materials set forth in Chapter 6 of the California Plumbing Code.

**3125B.2 Gauges.** A pressure and vacuum gauge shall be provided for each pump system. Each gauge shall have a scale range approximately  $1\frac{1}{4}$  times the maximum anticipated working pressure or vacuum and shall be accurate within 2 percent of scale.

**3125B.3 Flow meter.** A flow meter shall be provided on each recirculation system accurate to within 10 percent of flow and installed according to the manufacturer's written instructions with increments in the range of normal flow.

**3125B.4 Basket strainer.** A basket strainer shall be provided on the suction side of the recirculation pump. A basket strainer will not be required on pumps connected to vacuum filters where the filter elements are not removed for cleaning.

**3125B.5 Backwash piping.** Piping, including necessary valves conforming to Section 3125B.1, shall be provided for each filter vessel or element which requires periodic backwashing.

**3125B.6 Valves.** Valves shall not be located in any deck area surrounding a pool. Valves shall be installed on all recirculation, backwashing and drain system lines which require shutoff isolation, adjustment or control of the rate of flow. Each valve shall be installed in the equipment area and labeled as to its purpose.

### SECTION 3126B RECIRCULATION PUMP CAPACITY

**3126B.1** Pool recirculation pumps shall have the following total dynamic head capacities:

- 1. Pressure diatomaceous earth filters.** At least 60 feet (18,288 mm);
- 2. Vacuum diatomaceous earth filters.** Twenty inches (508 mm) vacuum on the suction side and 40 feet (12,192 mm) total dynamic head;
- 3. Rapid sand filters.** At least 45 feet (13,716 mm);
- 4. High rate sand filters.** At least 60 feet (18,288 mm); and
- 5. Cartridge filters.** At least 60 feet (18,288 mm).

**3126B.2.** Pumps with other total dynamic head capacities shall be permitted provided the turnover times are maintained as required in Section 3124B.

### SECTION 3127B WATER SUPPLY INLETS

**3127B.1 General.** Each pool shall be supplied with potable water by means of a permanently installed pipeline from a public water supply system holding a permit from the California Department of Public Health or from a source approved by the enforcing agent.

**3127B.2 Backflow prevention.** There shall be no direct connection between any potable water supply system and the pool or its piping system unless protected by a backflow prevention device accordance with Chapter 6 of the California Plumbing Code.

### SECTION 3128B FILTERS (ALL TYPES)

**3128B.1 General requirements.** All filters, regardless of type, shall be designed and constructed according to the applicable requirements established by the NSF/ANSI 50-2010 performance standard effective August 2010.

**3128B.2 Installation.** Each filter vessel shall be installed, piped and provided with valves so that it can be isolated from the recirculation system for repairs and backwashing.

**3128B.3**

### SECTION 3129B RAPID SAND PRESSURE FILTERS

In addition to the requirements for all filters as indicated in Section 3128B, the following apply to rapid sand pressure filters.

**3129B.1 Flow rates.** The filtration rate shall not exceed 3 gpm per square foot (122.24 L/m per m<sup>2</sup>) of filter area. The backwash rate shall not be less than 15 gpm per square foot (611.2 L/m per m<sup>2</sup>) of filter area.

**3129B.2 Filter media.** The filter shall contain not less than a 20-inch (508 mm) depth of media and not less than a 10-inch (254 mm) depth of filter gravel above the underdrain system.

**3129B.2.1** The filter media shall have an effective particle size between 0.40 and 0.55 millimeters and a uniformity coefficient not exceeding 1.75.

**3129B.2.2** The filter gravel shall be sized and placed to provide uniform flow distribution from the underdrain system and to support the bed of filter sand without loss of sand to the pool or without development of jet streams or channeling in the filtration media.

### SECTION 3130B DIATOMACEOUS EARTH FILTERS

In addition to the requirements for all filters as indicated in Section 3128B, the following apply to diatomaceous earth filters.

**3130B.1 Flow rates.** The filtration rate for both pressure and vacuum diatomaceous earth filters shall not exceed 2 gpm per square foot (81.49 L/m per m<sup>2</sup>) of filter area.

### SECTION 3131B HIGH-RATE SAND FILTERS

In addition to the requirements for all filters as indicated in Section 3128B, the following apply to high rate sand filters.

**3131B.1 Flow rates.** Maximum and minimum flow rates for backwash and filtration shall be maintained according to the applicable requirements established by the NSF/ANSI 50-2010 performance standard effective August 2010.

- > **3131B.2** The filter media shall have an effective particle size between 0.40 and 0.55 mm and a uniformity coefficient not exceeding 1.75.
- > **3131B.3** The backwash rate for a high rate sand filter shall be a minimum of 15 gpm per square foot of filter area.

### SECTION 3132B CARTRIDGE FILTERS

In addition to the requirements for all filters as indicated in Section 3128B, the following apply to cartridge filters.

- > **3132B.1** The filtration rate shall not exceed 0.375 gpm per square foot of filter area.
- > **3132B.2** An approved wash down area equipped with potable water shall be provided in the pool equipment area with permanently installed drainage piping discharging to the public sewer or wastewater system approved by the enforcing wastewater agency. The filter vessel shall be capable of being drained and shall be equipped with an indirect drain for the purpose of draining the entire contents of the filter vessel. Drainage and backwash piping shall be considered indirect waste and installed in accordance with the requirements of Chapter 8 of the California Plumbing Code.
- > **3132B.3** An additional set of filter elements shall be available for installation while the existing filter elements are cleaned.

### SECTION 3133B CHEMICAL FEEDERS

- > All chemical feeders including disinfectant feeders and the auxiliary feeders used for solutions, slurries or solids, along with components such as pumps, strainers, tubing connections, tanks and injection fittings shall comply with the provisions of this section.

**3133B.1 General design requirements.** The chemical feeder equipment shall:

1. Be maintained and repaired according to manufacturers' specifications;
2. Be constructed with an adjustable output rate device to permit repeated adjustments without loss of output rate accuracy and adjusted by an automatic chemical monitoring and control system; and
3. Meet the applicable requirements established by the NSF/ANSI 50-2010 performance standard effective August 2010.

- > **3133B.2 Piping.** Piping used for the chemical feeder and its auxiliary equipment shall be resistant to corrosion or chemical deterioration.

**3133B.3 Installation.** Chemical feeders and associated components shall be constructed and installed to prevent uncontrolled discharge or siphoning of chemicals and fumes directly into the pool, its recirculation system, the pool area or ancillary facilities.

### SECTION 3134B DISINFECTANT FEEDERS

Disinfectant feeders shall comply with applicable requirements established by the NSF/ANSI 50-2010 performance standard effective August 2010 for disinfectant feeders. In addition to the requirements for chemical feeders as indicated in Section 3133B, the following apply to disinfectant feeders.

**3134B.1 Minimum capacity.** All feeders shall be capable of supplying not less than the equivalent of 3 pounds (1 kg) of 100 percent available chlorine per day per 10,000 gallons (37,850 L) of pool water capacity.

**3134B.2 Rate of flow adjustment.** A visible means of determining the rate of flow through the device shall be provided for each disinfectant feeder.

**3134B.3 Compressed chlorine gas disinfectant equipment.** Chlorine gas shall not be dispensed directly into the water of a pool except as an aqueous solution through the return line of the recirculation system.

**3134B.3.1 Compressed gas containers.** Each container or cylinder shall be secured to prevent accidental movement. A valve protection cap shall be provided to cover the discharge valve at all times when the cylinder is not connected to the dispensing system.

**3134B.3.2 Container scale.** Compressed gas chlorine containers in use shall be on a scale in the gas chlorinator room.

**3134B.3.3 Chlorine feeding device.** The chlorine feeding device shall be capable of delivering chlorine in an aqueous solution at the maximum design rate. The device shall not allow the backflow of pool water into the chlorine container. The device shall not allow the release of chlorine gas to the atmosphere under normal operating conditions. The device shall be designed and installed to conduct chlorine gas leaks to the outdoors during a release of chlorine gas or an interruption of the water supply.

**3134B.3.4 Piping.** Piping carrying chlorine gas under pressure shall not be located outside the gas chlorination equipment room.

### SECTION 3135B GAS CHLORINATION EQUIPMENT ROOM

Compressed chlorine gas storage containers and auxiliary components shall be installed indoors in a separate room of not less than 1-hour fire resistant construction and shall comply with the California Fire Code and all of the following.

**3135B.1 Location.** The gas chlorination equipment room shall not be located in any habitable building, above the first floor or below ground level.

> **3135B.2. Exit.** Required exit doors shall swing in the direction of exit of travel and shall not open directly toward the pool or pool deck.

**3135B.3 Ventilation.** Mechanical exhaust ventilation systems shall be in compliance with the California Mechanical Code.

**3135B.4 Alarm.** An audible and visible chlorine detection alarm system shall be located in the room containing the gas chlorine equipment. The sensor shall be located within 6 inches (152 mm) of the floor level. The system shall continually monitor the room and shall activate when chlorine concentrations in the room exceed a Permissible Exposure Limit of 0.5 ppm. Activation of the alarm shall shut off the chlorine at the source and turn on the lights and ventilation system. The alarm system shall consist of the following:

1. An audible alarm capable of producing a sound level of at least 90 decibels; and
2. A visible alarm consisting of a strobe light which is mounted directly over the entrance to the chlorine equipment room. The light shall be visible during daylight hours.

**3135B.5 Illumination.** Artificial illumination of at least 50 footcandles as measured 30 inches (750 mm) from the floor shall be provided in the room.

**3135B.6 Switches.** Switches for the control of mechanical ventilation and lighting fixtures shall be located adjacent to the entry door outside the room.

**3135B.7 Equipment interlocks.** The gas chlorine feeding device shall be interlocked with the pool recirculating pump so that the gas chlorine feeding device shall not operate when the recirculating pump is off or during the filter backwash.

**3135B.8 Storage.** The gas chlorine room shall not be used for the storage of items not related to the use of the gas chlorine equipment.

### SECTION 3136B POOL SKIMMING SYSTEMS

> The pool shall be equipped with one or more skimming methods to provide continuous skimming of the pool water and shall be capable of continually withdrawing not less than 75 percent of the required flow rate.

**3136B.1 Surface skimmers.** Each surface skimmer shall comply with the following provisions:

1. The skimmer shall be recessed into the pool wall; and
2. The skimmer shall be individually adjustable for the rate of flow with either an external or internal device; and
3. If used, a skimmer equalizer suction outlet located on the pool wall shall be connected to at least two suction grate assemblies that meet the ASME/ANSI A112.19.8 performance standard and located at least 3 feet (915 mm) apart in any dimension between the drains; and
4. The skimmer weir shall automatically adjust to variations in the pool water level over a range of not less than 4 inches (102 mm); and

5. The skimmer shall be provided with an air lock protective device which shall not permit leakage of air into the recirculation suction piping system. This device shall not leak more than 3 gpm (11.356 L/m) of water during normal operations; and
6. Each skimmer shall be provided with a removable and cleanable screen or basket to trap objects. The screen or basket shall be accessible through an opening in the deck above the skimmer; and
7. There shall be a minimum of one skimmer for every 500 square feet or less of pool water surface area or an adequate number to meet 100 percent of pump flow at the manufacturer's maximum flow rating, whichever is greater; and
8. Each skimmer shall be located in relation to pool inlets to aid recirculation and surface skimming; and
9. All surface skimmers shall comply with applicable requirements established by the NSF/ANSI 50-2010 performance standard effective August 2010.

**3136B.2 Perimeter overflow systems.** A perimeter overflow system shall be required in pools whose water surface area equals or exceeds 5,000 square feet (464.52 m<sup>2</sup>). Perimeter overflow systems shall be designed by an engineer or architect as defined by this chapter who has experience working on public pools and shall comply with the following provisions:

1. **Location.** The overflow system shall be integrated with the pool structure and extend completely around the pool parallel to the pool deck except where an entry or exit may require interruption;
2. **Channel detail.** The overflow channel shall be not less than 3 inches (76 mm) deep, the section shall not diverge with depth of the channel, and the width of the bottom shall be not less than 3 inches (76 mm). The opening beneath the coping into the overflow system shall be a minimum of 4 inches (102 mm) beneath the coping in any direction measured radially from the inner edge of the overflow channel lip;
3. **Channel lip.** The overflow channel lip shall be not more than 12 inches (305 mm) below the level of the coping or deck. The lip edge shall be rounded and shall be not thicker than 2½ inches (64 mm) or thinner than 1 inch (25 mm) for the top 2 inches (51 mm);
4. **Channel covering.** Covered overflow channels shall be permitted provided the openings do not exceed ½ inch in the smaller dimension;
5. **Channel outlets.** Channel outlet spacing and channel bottom slope shall be hydraulically designed by an engineer or architect as defined by this Chapter who has experience working on public pools;
6. **Channel outlet covers.** Overflow channel outlet covers shall be accessible for cleaning and maintenance. Openings of the channel outlet covers shall not pass a ½ inch (13 mm) sphere in the smaller dimension;
7. **Channel drain piping.** Channel drain piping shall provide drainage of the overflow system, carry overflow water to a surge basin and return to skimming within 10

minutes after being flooded by a sudden displacement of the pool water by pool users;

8. **Surge storage capacity.** A perimeter overflow system shall be provided with a minimum surge storage capacity of not less than 1 gallon per square foot (40.75 L/m<sup>2</sup>) of pool water surface area. Surge storage shall be permitted in the surge basin, perimeter overflow channel and in the channel drain piping returning to the surge basin; and
9. **Water level control.** Automatic makeup water flow controls with a manual override control shall be provided to maintain the proper pool water level at the overflow rim.

### SECTION 3137B POOL FITTINGS

**3137B.1 Outlets.** Each pool shall be provided with a main drain submerged suction outlet typically located at the bottom of a pool that conducts water to a recirculating pump. Suction outlets shall comply with all of the following provisions:

1. Each pump on a pool system shall be connected to at least two suction outlets. The suction outlets shall be hydraulically balanced and symmetrically plumbed through one or more "T" fittings and shall be separated by a distance of at least 3 feet (915 mm) apart in any dimension between the suction outlets;
2. All suction outlets shall be equipped with suction fittings that meet the ASME/ANSI A112.19.8 performance standard;
3. The velocity of the suction piping installed between the suction outlets shall not exceed 3 feet per second (1.8 mps); and
4. **Hydrostatic relief devices.** In areas with a high groundwater table, or as required by local plumbing codes, a hydrostatic relief device shall be installed. When used in conjunction with a safety vacuum release system, the hydrostatic relief device must meet the manufacturer's installation requirements for the safety vacuum release system.

**3137B.2 Inlet fittings.** Each pool shall be provided with not less than two recirculation system inlets for the first 10,000 gallon (37,850 L) capacity and one additional inlet for each additional 10,000 gallon (37,850 L) or less capacity.

**3137B.2.1 Construction.** Inlet fittings shall not protrude greater than 1<sup>1</sup>/<sub>4</sub> inches (32 mm) into the pool and shall be shaped, rounded and smooth.

**3137B.2.2 Location.** Inlet fittings shall be located no less than 18 inches (457 mm) below the waterline, except for a spa pool or wading pool. Inlet fittings shall be separated by at least 10 feet (3048 mm) and shall be located so as to ensure uniform circulation.

**3137B.2.3 Adjustment.** Provisions shall be made for adjusting the volume of flow through each inlet. Wall inlets shall be capable of adjusting the direction of flow and to

produce sufficient velocity to impart a substantial circulatory movement to the pool water.

**3137B.2.4 Floor inlets.** Pools that are greater than 40 feet (12,192 mm) in width or 3,000 square feet (278.7 m<sup>2</sup>) in surface area shall have floor-mounted return inlets. The number of floor inlets shall be in compliance with Section 3137B.2. All floor inlet fittings shall be located to provide uniform circulation and shall be installed so as to be flush with the surface of the pool bottom.

### SECTION 3138B SPA POOL SPECIAL REQUIREMENTS

**3138B.1 Aeration system.** A spa pool aeration and/or jet system shall be completely separate from the recirculation system and shall not be interconnected with any other pool.

**3138B.2 Maximum operating temperature.** The allowable water temperature of a spa pool shall not exceed 104° F (57.8° C).

**3138B.3 Surface area.** The water surface area of a spa pool shall not exceed 250 square feet (23.23 m<sup>2</sup>).

**3138B.4 Maximum depth.** The water depth in a spa pool shall not exceed 4 feet (1220 mm).

**3138B.5 Emergency shut off switch.** A clearly labeled emergency shut off switch for the control of both the recirculation system and the aeration and/or jet system shall be installed adjacent to the spa pool.

### SECTION 3139B SOLAR HEATING INSTALLATIONS

**3139B.1** Solar heating systems shall comply with the following:

1. Solar heating system suction outlets shall comply with Section 3137B; and
2. Solar heating system suction outlets shall be located no closer than 5 feet (1525 mm) to any pool inlet fitting.
3. The installation of a solar heating system on a new or existing pool shall not interfere with the required turnover rate as specified in Section 3124B nor exceed the pipe flow velocities as specified in Section 3125B.1.

### SECTION 3140B CLEANING SYSTEMS

A vacuum cleaning system shall be available which is capable of removing sediment from all parts of the pool floor. A cleaning system using potable water shall be provided with an approved backflow protection device as required by the California Department of Public Health under Sections 7601 to 7605, Article 2, Title 17, California Code of Regulations. No cleaning system shall operate in the pool when the pool is open or available for use by pool users. Built-in vacuum suction lines shall not be installed in the pool.

**PUBLIC POOLS**

**SECTION 3141B  
WASTEWATER DISPOSAL**

**3141B.1 General requirements.** Material cleaned from filters and backwash water from any recirculation system shall be disposed in a manner that is acceptable to the local wastewater agency and will not create a nuisance. Backwash water shall not be returned to a pool. Pipes carrying wastewater from pools including pool drainage and backwash from filters shall be installed as an indirect waste in accordance with the requirements of Chapter 8 of the California Plumbing Code. Where a pump is used to discharge waste pool water to the drainage system, the pump discharge shall be installed as an indirect waste.

**3141B.2 Diatomaceous earth filters.** The backwash from a diatomaceous earth filter shall discharge into a separation tank that has been installed to collect the waste diatomaceous earth mixture. The wastewater from the separation tank shall discharge into a sanitary sewer or other disposal system acceptable to the local wastewater agency.

**3141B.3 Piping.** Sumps and drain piping shall have sufficient capacity to receive recirculation system backwash without overflow of the sump receiver. The sump shall not permit sewage to enter the surge basin or the pool in the event of a sewage backup

**3141B.4 Visual indicator.** Where direct observation of the backwash discharge is not visible to the operator during backwash operations, a sight glass shall be installed on the wastewater discharge line.

**3141B.5 Prohibited connection.** There shall be no direct connection between the pool, its recirculation system or overflow drain to any sanitary sewer, storm drain or drainage system.

**SECTION 3142B  
Reserved**

**SECTION 3143B  
Reserved**

**SECTION 3144B  
Reserved**

**SECTION 3145B  
Reserved**

**SECTION 3146B  
Reserved**

**SECTION 3147B  
Reserved**

**SECTION 3148B  
Reserved**

**SECTION 3149B  
Reserved**

**SECTION 3150B  
Reserved**

**SECTION 3151B  
Reserved**

**SECTION 3152B  
Reserved**

**SECTION 3153B  
Reserved**

**SECTION 3154B  
Reserved**

**SECTION 3155B  
Reserved**

**SECTION 3156B  
Reserved**

**SECTION 3157B  
Reserved**

**SECTION 3158B  
Reserved**

**SECTION 3159B  
Reserved**

**Division II – PUBLIC SWIMMING POOLS**

*Note:* These building standards are in statute but have not been adopted through the regulatory process. Enforcement of these standards set forth in this section does not depend upon adoption of regulations; therefore, enforcement agencies shall enforce the standards pursuant to the timeline set forth in this section prior to adoption of related regulations.

**SECTION 3160B  
GROUND FAULT CIRCUIT INTERRUPTERS**

1. "Public swimming pool," as used in this section, means any swimming pool operated for the use of the general public with or without charge, or for the use of the members and guests of a private club, including any swimming pool located on the grounds of a hotel, motel, inn, an apartment complex or any residential setting other

than a single-family home. For purposes of this section, "public swimming pool" shall not include a swimming pool located on the grounds of a private single-family home, or a swimming pool owned or operated by the state or any local governmental entity as set forth in Section 116049 of the Health and Safety Code.

2. All dry-niche light fixtures, and all underwater wet-niche light fixtures operating at more than 15 volts in public swimming pools, as defined in this section, shall be protected by a ground fault circuit interrupter in the branch circuit, and all light fixtures in public swimming pools shall have encapsulated terminals.
3. Any public swimming pool that does not meet the requirements specified in Item 2 by January 1, 1998, shall be retrofitted to comply with these requirements by July 1, 1998.
4. The ground-fault circuit interrupter required pursuant to this section shall comply with Underwriter's Laboratory standards.
5. The owner or operator of a public swimming pool shall have its public swimming pool inspected by a qualified inspector on or before September 1, 1998, to determine compliance with this section.
6. All electrical work required for compliance with this section shall be performed by an electrician licensed pursuant to Chapter 9 (commencing with Section 7000) of Division 3 of the Business and Professions Code.

### **SECTION 3161B WADING POOLS**

1. "Public wading pool" means a pool that meets all of the following criteria:
  - 1.1. It has a maximum water depth not exceeding 18 inches (457 mm).
  - 1.2. It is a pool other than a pool that is located on the premises of a one-unit or two-unit residence, intended solely for the use of the residents or guests.
2. "Public wading pool" includes, but is not limited to, a pool owned or operated by private persons or agencies, or by state or local governmental agencies.
3. "Public wading pool" includes, but is not limited to, a pool located in an apartment house, hotel or similar setting that is intended for the use of residents or guests.
4. "Alteration" means any of the following:
  - 4.1. To change, modify or rearrange the structural parts or the design.
  - 4.2. To enlarge.
  - 4.3. To move the location of.
  - 4.4. To install a new water circulation system.
  - 4.5. To make any repairs costing fifty dollars (\$50) or more to an existing circulation system.
5. A public wading pool shall have at least two circulation drains per pump that are hydraulically balanced and symmetrically plumbed through one or more T fittings,

and are separated by a distance of at least 3 feet (914 mm) in any dimension between drains.

6. All public wading pool main drain suction outlets that are under 12 inches (305 mm) across shall be covered with antivortex grates or similar protective devices. All main drain suction outlets shall be covered with grates or antivortex plates that cannot be removed except with the use of tools. Slots or openings in the grates or similar protective devices shall be of a shape, area and arrangement that would prevent physical entrapment and would not pose any suction hazard to bathers.
7. The maximum velocity in the pump suction hydraulic system shall not exceed 6 feet per second (1.8 m/s) when 100 percent of the pump's flow comes from the main drain system and any main drain suction fitting in the system is completely blocked.
8. On or after January 1, 1998, all newly constructed public wading pools shall be constructed in compliance with this section.
9. Commencing January 1, 1998, whenever a construction permit is issued for alteration of an existing public wading pool, it shall be retrofitted so as to be in compliance with this section.
10. By January 1, 2000, every public wading pool, regardless of the date of original construction, shall be retrofitted to comply with this section.

### **SECTION 3162 ANTI-ENTRAPMENT DEVICES AND SYSTEMS**

1. The Legislature finds and declares that the public health interest requires that there be uniform statewide health and safety standards for public swimming pools to prevent physical entrapment and serious injury to children and adults. It is the intent of the Legislature to occupy the whole field of health and safety standards for public swimming pools and the requirements established in this article shall be exclusive of all local health and safety standards relating to public swimming pools.
2. As used in this section, the following words have the following meanings:
  - (a) "ASME/ANSI performance standard" means a standard that is accredited by the American National Standards Institute and published by the American Society of Mechanical Engineers.
  - (b) "ASTM performance standard" means a standard that is developed and published by ASTM International.
  - (c) "Main drain" means a submerged suction outlet typically located at the bottom of a swimming pool that conducts water to a recirculating pump.
  - (d) "Public swimming pool" means an outdoor or indoor structure, whether in-ground or above-ground, intended for swimming or recreational bathing, including a swimming pool, hot tub,

spa, or nonportable wading pool, that is any of the following:

- (i) *Open to the public generally, whether for a fee or free of charge.*
  - (ii) *Open exclusively to members of an organization and their guests, residents of a multiunit apartment building, apartment complex, residential real estate development, or other multifamily residential area, or patrons of a hotel or other public accommodations facility.*
  - (iii) *Located on the premises of an athletic club, or public or private school.*
- (e) *“Qualified individual” means a contractor who holds a current valid license issued by the State of California or a professional engineer licensed in the State of California who has experience working on public swimming pools.*
- (f) *“Safety vacuum release system” means a vacuum release system that ceases operation of the pump, reverses the circulation flow, or otherwise provides a vacuum release at a suction outlet when a blockage is detected.*
- (g) *“Skimmer equalizer line” means a suction outlet located below the waterline and connected to the body of a skimmer that prevents air from being drawn into the pump if the water level drops below the skimmer weir. However, a skimmer equalizer line is not a main drain.*
- (h) *“Unblockable drain” means a drain of any size and shape that a human body cannot sufficiently block to create a suction entrapment hazard.*
3. *Subject to Subdivision (4), an ASME/ANSI or ASTM performance standard relating to anti-entrapment devices or systems or an amendment or successor to, or later published edition of an ASME/ANSI or ASTM performance standard relating to anti-entrapment devices or systems shall become the applicable standard in California 90 days after publication by ASME/ANSI or ASTM, respectively, provided that the performance standard or amendment or successor to, or later published edition is approved by the department within 90 days of the publication of the performance standard by ASME/ANSI or ASTM, respectively. Notwithstanding any other law, the department may implement, interpret, or make specific the provisions of this section by means of a policy letter or similar instruction and this action by the department shall not be subject to the rulemaking requirements of the Administrative Procedure Act (Chapter 3.5 (commencing with Section 11340) of Part 1 of Division 3 of Title 2 of the Government Code).*
4. *Subject to Subdivision (7), every public swimming pool shall be equipped with anti-entrapment devices or systems that comply with ASME/ANSI performance standard A112.19.8, as in effect December 31, 2009, or any applicable ASME/ANSI performance standard that has been adopted by the department pursuant to Subdivision (3).*
5. *Subject to Subdivisions (6) and (7), every public swimming pool with a single main drain that is not an unblockable drain shall be equipped with at least one or more of the following devices or systems that are designed to prevent physical entrapment by pool drains:*
- (a) *A safety vacuum release system that has been tested by a department-approved independent third party and found to conform to ASME/ANSI performance standard A112.19.17, as in effect on December 31, 2009, or any applicable ASME/ANSI performance standard that has been adopted by the department pursuant to Subdivision (3), or ASTM performance standard F2387, as in effect on December 31, 2009, or any applicable ASTM performance standard that has been adopted by the department pursuant to Subdivision (3).*
  - (b) *A suction-limiting vent system with a tamper-resistant atmospheric opening, provided that it conforms to any applicable ASME/ANSI or ASTM performance standard that has been adopted by the department pursuant to Subdivision (3).*
  - (c) *A gravity drainage system that utilizes a collector tank, provided that it conforms to any applicable ASME/ANSI or ASTM performance standard that has been adopted by the department pursuant to Subdivision (3).*
  - (d) *An automatic pump shut-off system tested by a department-approved independent third party and found to conform to any applicable ASME/ANSI or ASTM performance standard that has been adopted by the department pursuant to Subdivision (3).*
  - (e) *Any other system that is deemed, in accordance with federal law, to be equally effective as, or more effective than, the systems described in paragraphs (a) to (d), inclusive, at preventing or eliminating the risk of injury or death associated with pool drainage systems.*
6. *Every public swimming pool constructed on or after January 1, 2010, shall have at least two main drains per pump that are hydraulically balanced and symmetrically plumbed through one or more “T” fittings, and that are separated by a distance of at least three feet in any dimension between the drains. A public swimming pool constructed on or after January 1, 2010, that meets the requirements of this subdivision, shall be exempt from the requirements of Subdivision (5).*
7. *A public swimming pool constructed prior to January 1, 2010, shall be retrofitted to comply with Subdivisions (4) and (5) by no later than July 1, 2010, except that no further retrofitting is required for a public swimming pool that completed a retrofit between December 19, 2007, and January 1, 2010, that complied with the Virginia Graeme Baker Pool and Spa Safety Act (15 U.S.C. Sec. 8001 et seq.) as in effect on the date of issue of the construction permit, or for a nonportable wading pool that completed a retrofit prior to January 1, 2010, that com-*

- plied with state law on the date of issue of the construction permit. A public swimming pool owner who meets the exception described in this subdivision shall do one of the following prior to September 30, 2010:
- a. File the form issued by the department pursuant to subdivision (g), as otherwise provided in subdivision (h).
  - b. File a signed statement attesting that the required work has been completed.
  - c. Provide a document containing the name and license number of the qualified individual who completed the required work.
  - d. Provide either a copy of the final building permit, if required by the local agency, or a copy of one of the following documents if no permit was required:
    - (i) A document that describes the modification in a manner that provides sufficient information to document the work that was done to comply with federal law.
    - (ii) A copy of the final paid invoice. The amount paid for the services may be omitted or redacted from the final invoice prior to submission.
8. Prior to March 31, 2010, the department shall issue a form for use by an owner of a public swimming pool to indicate compliance with this section. The department shall consult with county health officers and directors of departments of environmental health in developing the form and shall post the form on the department's Internet Web site. The form shall be completed by the owner of a public swimming pool prior to filing the form with the appropriate city, county, or city and county department of environmental health. The form shall include, but not be limited to, the following information:
- a. A statement of whether the pool operates with a single or split main drain.
  - b. Identification of the type of anti-entrapment devices or systems that have been installed pursuant to Subdivision (4) and the date or dates of installation.
  - c. Identification of the type of devices or systems designed to prevent physical entrapment that have been installed pursuant to Subdivision (5) in a public swimming pool with a single main drain that is not an unblockable drain and the date or dates of installation or the reason why the requirement is not applicable.
  - d. A signature and license number of a qualified individual who certifies that the factual information provided on the form in response to paragraphs (a) to (c), inclusive, is true to the best of his or her knowledge.
9. A qualified individual who improperly certifies information pursuant to Paragraph (d) of Subdivision (8) shall be subject to potential disciplinary action at the discretion of the licensing authority.
10. Except as provided in Subdivision (7), each public swimming pool owner shall file a completed copy of the form issued by the department pursuant to this section with the city, county, or city and county department of environmental health in the city, county, or city and county in which the swimming pool is located. The form shall be filed within 30 days following the completion of the swimming pool construction or installation required pursuant to this section or, if the construction or installation is completed prior to the date that the department issues the form pursuant to this section, within 30 days of the date that the department issues the form. The public swimming pool owner or operator shall not make a false statement, representation, certification, record, report, or otherwise falsify information that he or she is required to file or maintain pursuant to this section.
11. In enforcing this section, health officers and directors of city, county, or city and county departments of environmental health shall consider documentation filed on or with the form issued pursuant to this section by the owner of a public swimming pool as evidence of compliance with this section. A city, county, or city and county department of environmental health may verify the accuracy of the information filed on or with the form.
12. To the extent that the requirements for public wading pools imposed by Section 116064 conflict with this section, the requirements of this section shall prevail.
- a. Until January 1, 2014, the department may assess an annual fee on the owners of each public swimming pool, to be collected by the applicable local health department, in an amount not to exceed the amount necessary to defray the department's costs of carrying out its duties under Section 116064.1 and this section but in no case shall this fee exceed six dollars (\$6).
  - b. The local health department may retain a portion of the fee collected pursuant to paragraph (a) in an amount necessary to cover the administrative costs of collecting the fee, but in no case to exceed one dollar (\$1).
  - c. The local health department shall bill the owner of each public swimming pool in its jurisdiction for the amount of the state fee. The local health department shall transmit the collected state fee to the Controller for deposit into the Recreational Health Fund, which is hereby created in the State Treasury. The local health department shall not be required to take action to collect an unpaid state fee, but shall submit to the department, every six months, a list containing the name and address of the owner of each public swimming pool who has failed to pay the state fee for more than 90 days after the date that the bill was provided to the owner of the public swimming pool.
  - d. Owners that are exempt from local swimming pool permit fees shall also be exempt from the fees imposed pursuant to this subdivision.

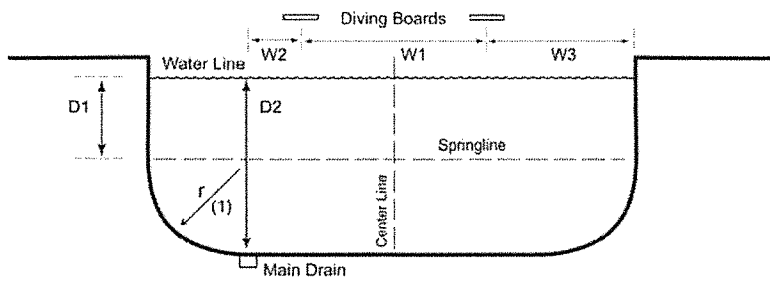
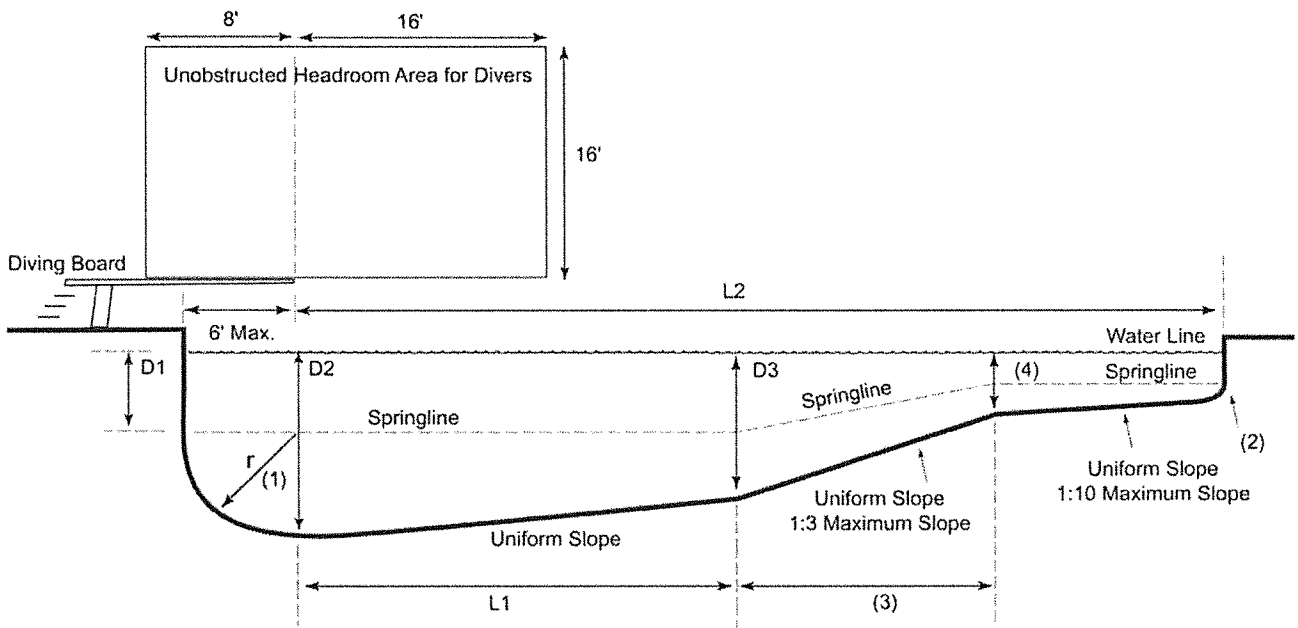


**PUBLIC POOLS**

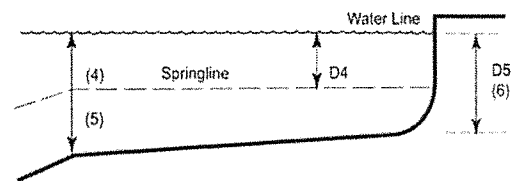
e. Except as provided in paragraph (b), all moneys collected by the department pursuant to this section shall be deposited into the Recreational Health Fund. Notwithstanding Section 16305.7 of the Government Code, interest and dividends on moneys in the Recreational Health Fund shall also

be deposited in the fund. Moneys in the fund shall, upon appropriation by the Legislature, be available to the department for carrying out its duties under Section 116064.1 and this section and shall not be redirected for any other purpose.

**LONGITUDINAL SECTION**



**Transverse Section Deep End Through Main Drain**



**Transverse Section Shallow End**

**FIGURE 31B-1  
DEPTHS AND CLEARANCES FOR POOLS WITH DIVING BOARDS  
GREATER THAN 30 INCHES (762 mm) ABOVE THE WATER LINE**

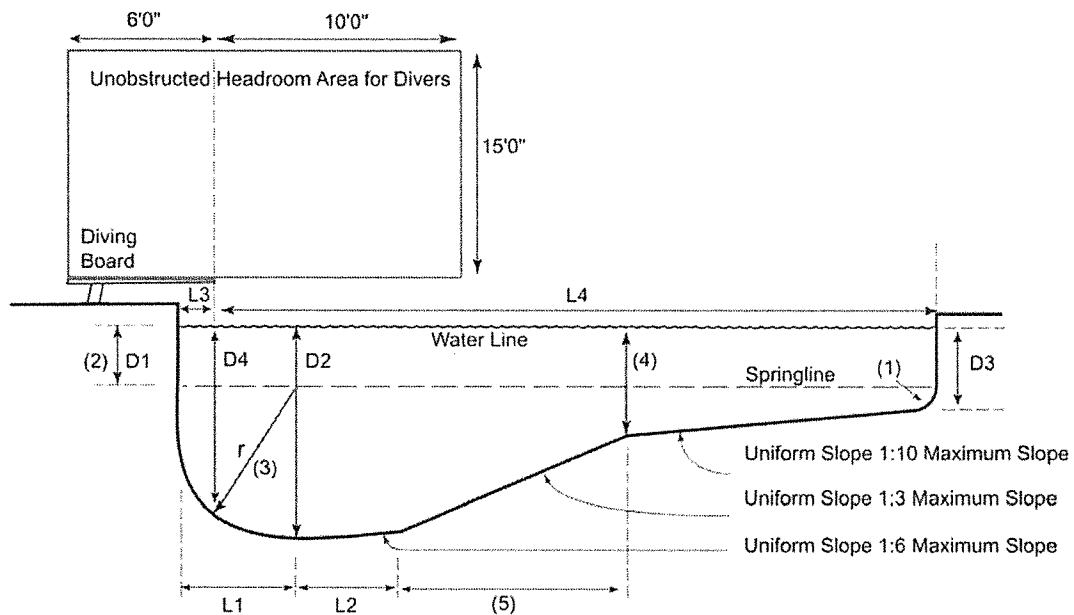
TABLE 31B-1

BOARDS AND PLATFORMS	DIM	DEPTH OF WATER					LENGTH OF SECTION				
		D1	D2	D3	D4	D5	L1	L2	W1	W2	W3
1-Meter Board	Min	6' 0"	12' 0"	11' 0"	2' 6"	0' 0"	20' 0"	30' 0"	10' 0"	5' 0"	11' 0"
3-Meter Board	Min	7' 0"	13' 0"	12' 0"	2' 6"	0' 0"	20' 0"	40' 0"	10' 0"	5' 0"	12' 0"

Notes for Figure 31B-1 and Table 31B-1:

1. Maximum radius shall equal D2 minus D1 dimensions.
2. Radius at the shallow end shall be not less than 6 inches nor more than 12 inches.
3. The length of a section is based on the maximum slope and other maximum and minimum dimensions.
4. Where there is a break in slope, the break shall be located at a water depth equal to 4' 6".
5. The springline depth at (4) shall not be less than 2' 6" nor more than 4' 0".
6. The maximum water depth shall be 3' 6".
7. The main drain shall be located to provide complete drainage of the pool.

LONGITUDINAL SECTION



TRANSVERSE SECTION AT D2

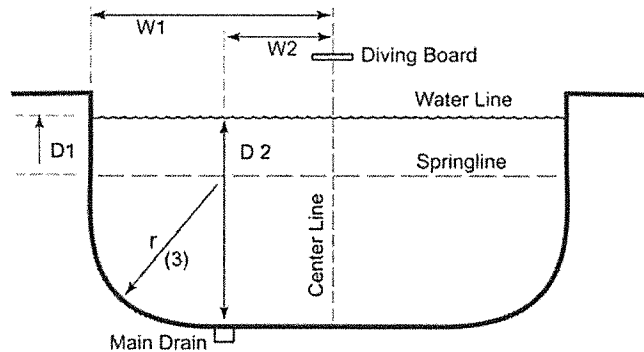


FIGURE 31B-2 DEPTHS AND CLEARANCES FOR POOLS WITH DIVING BOARDS 30 INCHES (762 MM) OR LESS ABOVE THE WATER LINE

**PUBLIC POOLS**

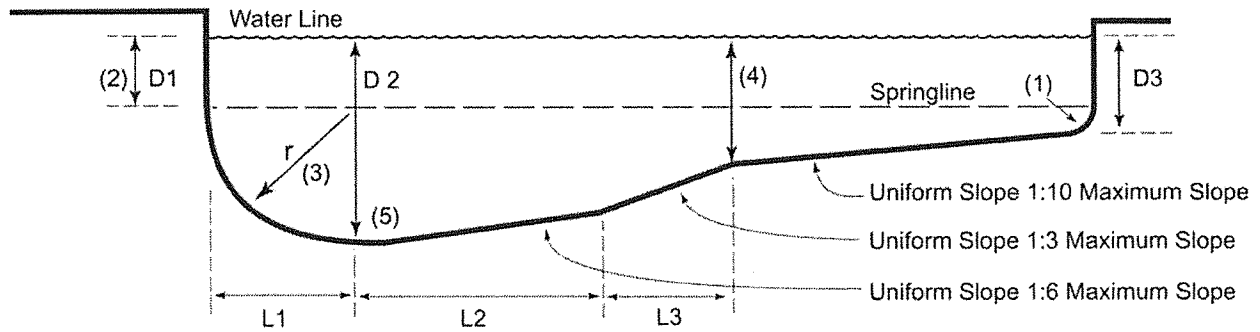
**TABLE 31B-2**

Dimension	DEPTH OF WATER				LENGTH OF SECTION					
	D1	D2	D3	D4	L1	L2	L3	L4	W1	W2
Minimum	2' 6"	8' 6"	0' 0"	7' 0"	6' 0"	6' 0"	2' 6"	30' 0"	9' 0"	3' 0"
Maximum	—	—	3' 6"	—	10' 0"	—	4' 0"	—	—	—

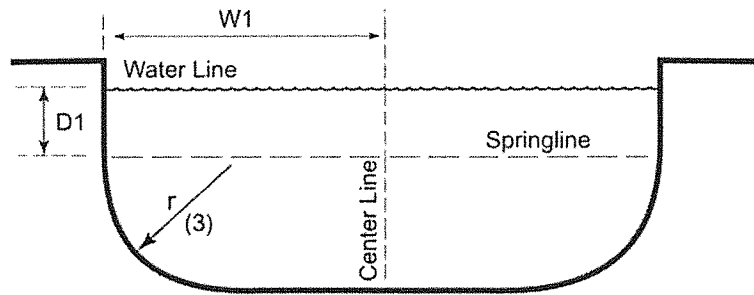
Notes for Figure 31B-2 and Table 31B-2:

1. Radius at the shallow end shall be a minimum of 0' 6" and a maximum of 1' 0".
2. Springline D1 shall extend to the break in slope between the shallow area and the deep area.
3. Maximum radius shall equal D2 minus D1 dimensions.
4. Where there is a break in slope, the break in slope shall be located at a water depth equal to 4' 6".
5. Length of section based on maximum slope and other maximum or minimum dimensions.
6. The main drain shall be located to provide complete drainage of the pool.

**LONGITUDINAL SECTION**



**TRANSVERSE SECTION AT D2**



**FIGURE 31B-3**  
**DEPTHS AND CLEARANCES FOR POOLS WITHOUT DIVING BOARDS**

**TABLE 31B-3A  
POOLS WITH MAXIMUM WATER DEPTH = 6' 0"**

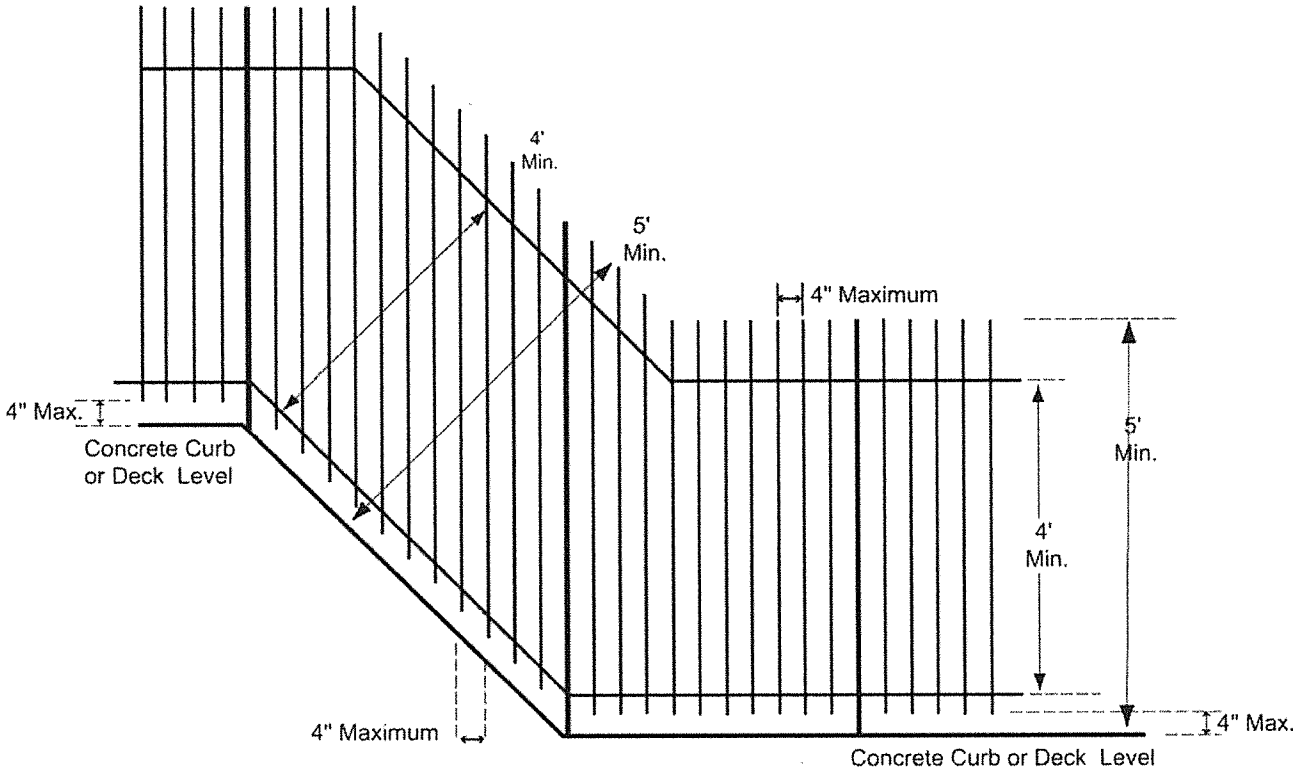
<i>Dimension</i>	<i>DEPTH OF WATER</i>			<i>LENGTH OF SECTION</i>			
	<i>D1</i>	<i>D2</i>	<i>D3</i>	<i>L1</i>	<i>L2</i>	<i>L3</i>	<i>W1</i>
<i>Minimum</i>	2' 6"	(5)	0' 0"	3' 6"	3' 0"	3' 0"	6' 0"
<i>Maximum</i>	—	6' 0"	3' 6"	—	—	—	—

**TABLE 31B-3B  
POOLS WITH MAXIMUM WATER DEPTH > 6' 0"**

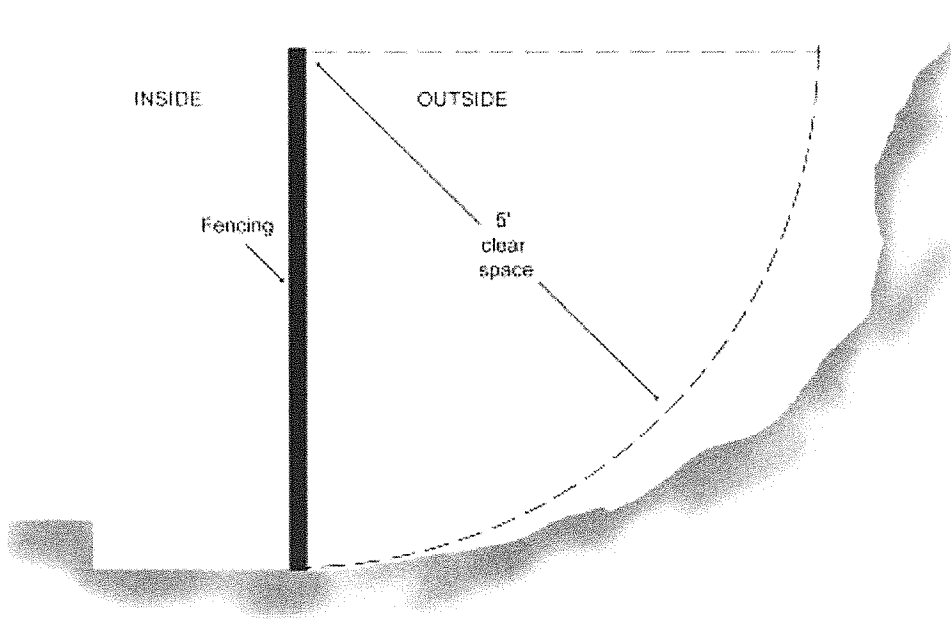
<i>Dimension</i>	<i>DEPTH OF WATER</i>			<i>LENGTH OF SECTION</i>		
	<i>D1</i>	<i>D2</i>	<i>D3</i>	<i>L1</i>	<i>L2</i>	<i>W1</i>
<i>Minimum</i>	2' 6"	(5)	0' 0"	3' 6"	3' 0"	7' 6"
<i>Maximum</i>	—	—	3' 6"	—	—	—

Notes for Figure 31B-3 and Tables 31B-3a and 31B-3b:

1. Radius at the shallow end shall be a minimum of 0' 6" and a maximum of 1' 0".
2. Springline D1 shall extend to the break in slope between the shallow area and the deep area.
3. Maximum radius shall equal D2 minus D1 dimensions.
4. Where there is a break in slope, the break in slope shall be located at a water depth equal to 4' 6".
5. The main drain shall be located to provide complete drainage of the pool.

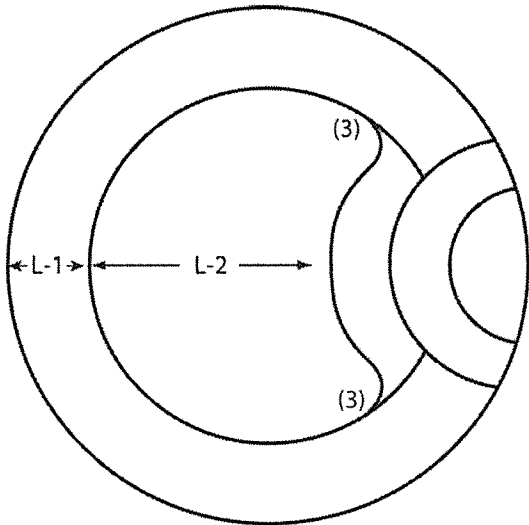


**FIGURE 31B-4  
PERPENDICULAR FENCING DIMENSIONS ON SLOPING GROUND**



**FIGURE 31B-5  
EFFECTIVE FENCING HEIGHT**

TOP VIEW



TRANSVERSE SECTION

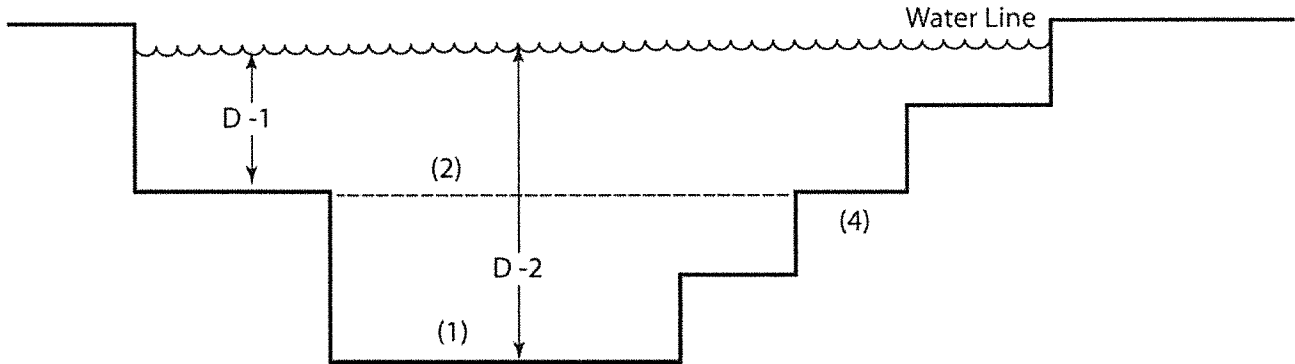


FIGURE 31B-6  
DEPTHS AND DIMENSIONS FOR SPA POOLS

TABLE 31B-6

Dimension	DEPTH OF WATER		LENGTH OF SECTIONS	
	D1	D2	L1	L2
Minimum	—	24"	12"	24"
Maximum	24"	42"	24"	—

Notes for Figure 31B-6 and Table 31B-6:

1. Bottom slope shall not exceed 1:10 and must be uniform.
2. Bench ramping shall not exceed 1:10 uniform slope, measured at the inner circumference of the bench.
3. Six inch minimum radius at "pinch points."
4. See Sections 3111B and 3112B for step and handrail dimensions.

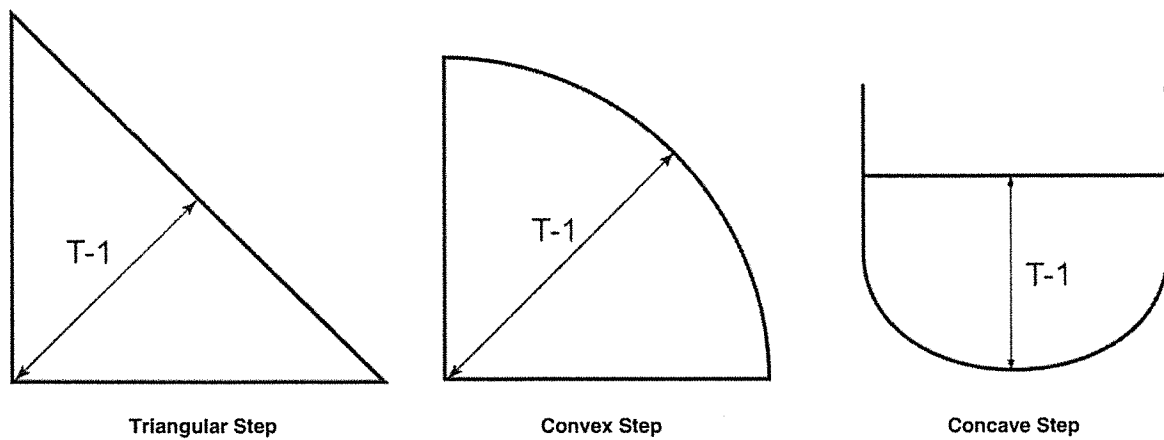
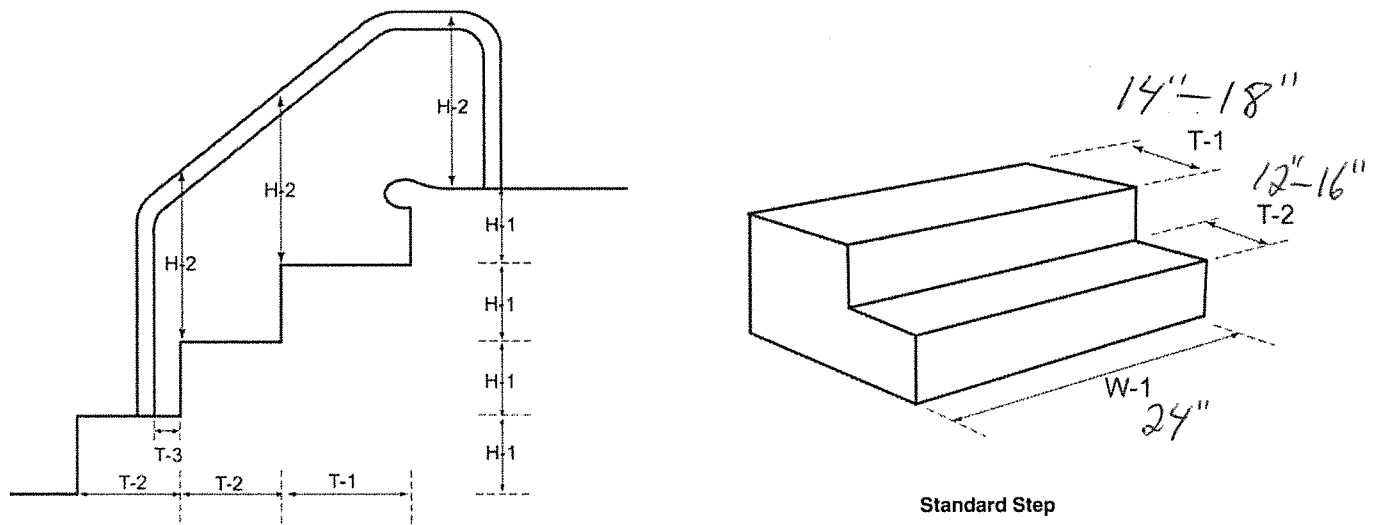


FIGURE 31B-7  
STAIR AND HANDRAIL DIMENSIONS



**PUBLIC POOLS**

**TABLE 31B-7**

<b>DIMENSIONS</b>	<b>T-1 STANDARD</b>	<b>T-1 TRIANGULAR, CONCAVE, CONVEX</b>	<b>T-2</b>	<b>T-3</b>	<b>W-1</b>	<b>H-1</b>	<b>H-2</b>
<i>Minimum</i>	14"	21"	12"	3"	24"	6"	28"
<i>Maximum</i>	18"	24"	16"	—	—	12"	36"